

# Deluxe Straight Picket Fence

**1 1/2" Picket - 36", 48" High**

**New!**  
**4"x4" Post**

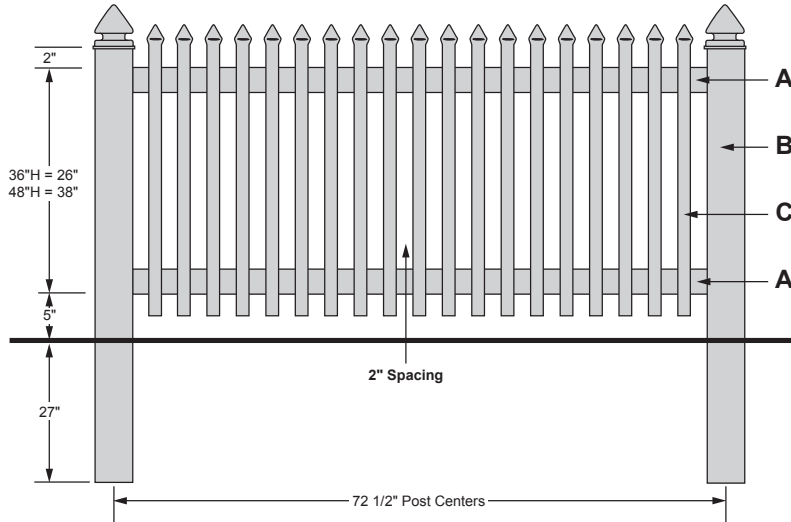

- A - 2" x 4" x 71 1/2" Drilled Rails
- B - 4" x 4" Posts  
36" High = 60" Post Length  
48" High = 72" Post Length
- C - (19) 7/8" x 1 1/2" Pre-Drilled Pickets  
36" High = 34" Long Pickets  
48" High = 46" Long Pickets



**POOL CODE STYLES REQUIRE 2 WEEK LEAD TIME**



**1 1/2" Picket - 48" High**

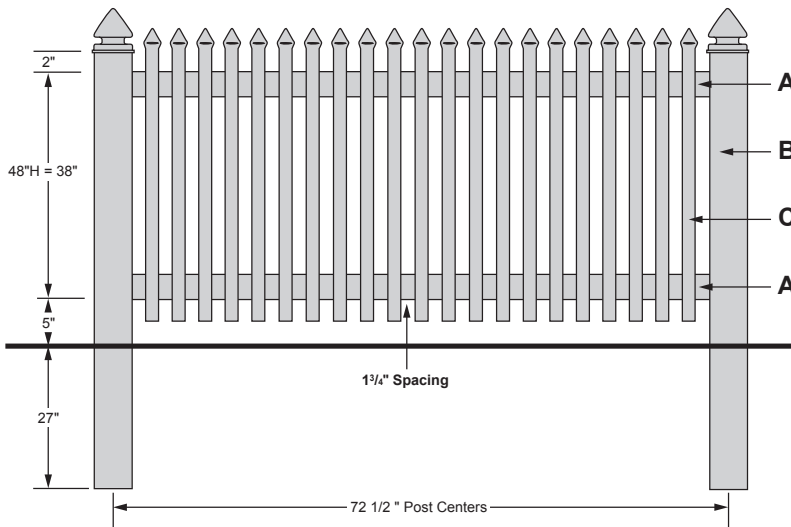

- A - 2" x 4" x 71 1/2" Drilled Rails
- B - 4" x 4" Posts  
48" High = 72" Post Length
- C - (21) 7/8" x 1 1/2" Pre-Drilled Pickets  
48" High = 46" Long Pickets

## Product Information (6' Sections)

1 1/2" x 36", 48" High Deluxe Straight Picket Fence. All sections include 1-post per section, additional posts available, see price sheet.



48" available to meet pool code.

**Sections under or over 6' long - 15% extra for special fabrication**  
**Colors Available - White, (Ivory & Gray - 15% Extra)**

# Deluxe Straight Picket Fence

## 3" Picket - 36" - 48" High

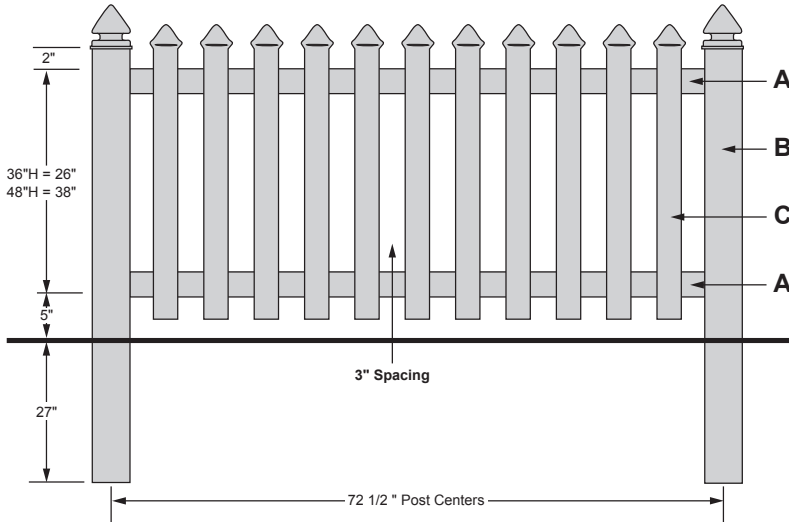

- A - 2" x 4" x 71½" Drilled Rails
- B - 4" x 4" Posts  
36" High = 60" Post Length  
48" High = 72" Post Length
- C - (11) 7/8" x 3" Pre-Drilled Pickets  
36" High = 34" Long Pickets  
48" High = 46" Long Pickets



POOL CODE STYLES REQUIRE 2 WEEK LEAD TIME



## 3" Picket - 48" High

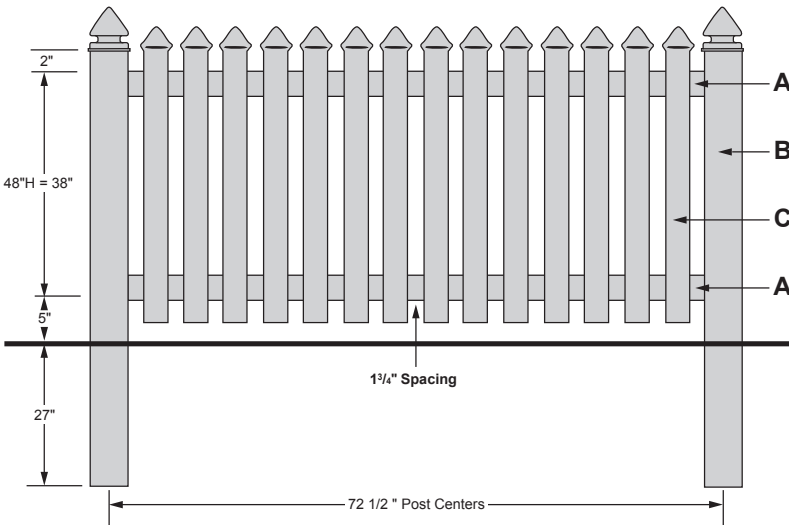

- A - 2" x 4" x 71½" Drilled Rails
- B - 4" x 4" Posts  
48" High = 72" Post Length
- C - (14) 7/8" x 3" Pre-Drilled Pickets  
48" High = 46" Long Pickets

### Product Information (6' Sections)

3" x 36", 48" High Deluxe Straight Picket Fence. All sections include 1-post per section, additional posts available, see price sheet.



48" available to meet pool code.

Sections under or over 6' long - 15% extra for special fabrication  
Colors Available - White, (Ivory & Gray - 15% Extra)

# Deluxe Straight Picket Fence

## 1 1/2" Picket - 60", 72" High

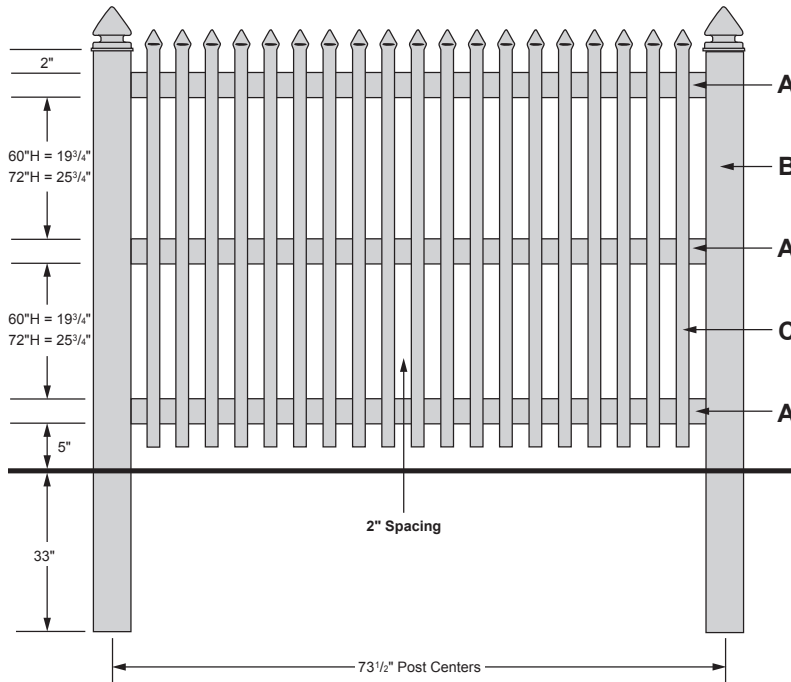

- A - 2" x 4" x 71 1/2" Drilled Rails
- B - 5" x 5" Posts  
60" High = 90" Post Length  
72" High = 102" Post Length
- C - (19) 7/8" x 1 1/2" Pre-Drilled Pickets  
60" High = 58" Long Pickets  
72" High = 70" Long Pickets



**POOL CODE STYLES REQUIRE 2 WEEK LEAD TIME**



## 1 1/2" Picket - 60", 72" High

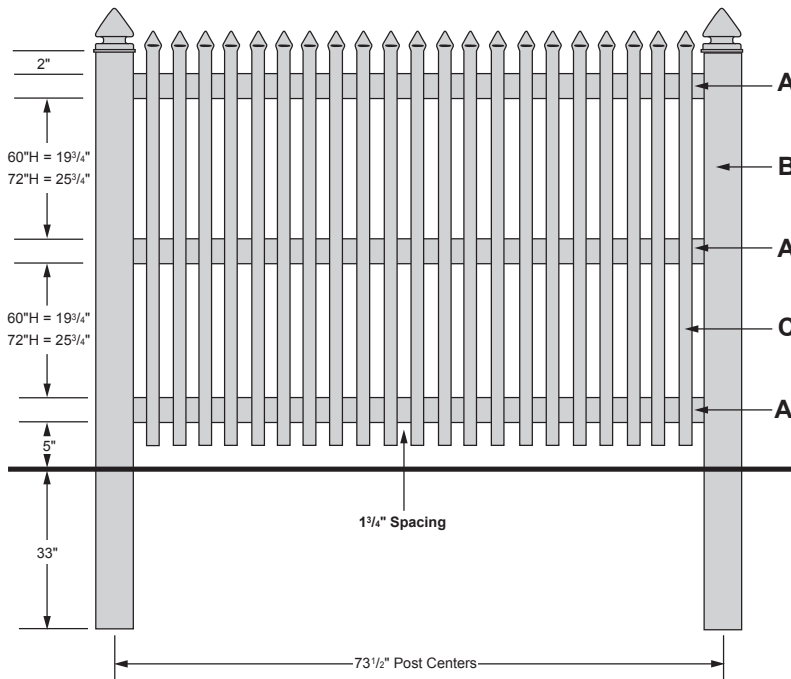

- A - 2" x 4" x 71 1/2" Drilled Rails
- B - 5" x 5" Posts  
60" High = 90" Post Length  
72" High = 102" Post Length
- C - (21) 7/8" x 1 1/2" Pre-Drilled Pickets  
60" High = 58" Long Pickets  
72" High = 70" Long Pickets

### Product Information (6' Sections)

1 1/2" x 60", 72" High Deluxe Straight Picket Fence. All sections include 1-post per section, additional posts available, see price sheet.



60", 72" available to meet pool code.

Sections under or over 6' long - 15% extra for special fabrication  
Colors Available - White, (Ivory & Gray - 15% Extra)

# Deluxe Straight Picket Fence

## 3" Picket - 60", 72" High

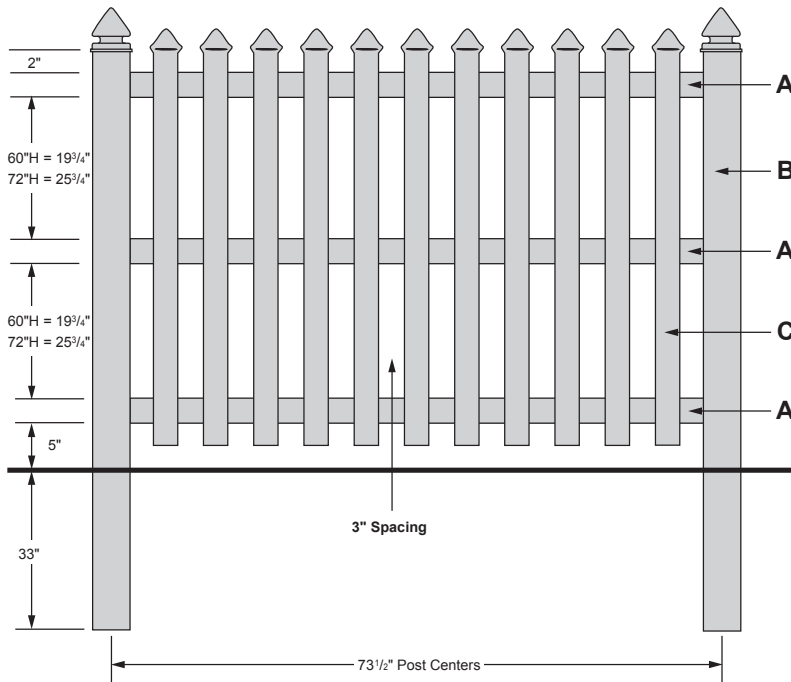

- A - 2" x 4" x 71½" Drilled Rails
- B - 5" x 5" Posts  
60" High = 90" Post Length  
72" High = 102" Post Length
- C - (11) 7/8" x 3" Pre-Drilled Pickets  
60" High = 58" Long Pickets  
72" High = 70" Long Pickets



**POOL CODE STYLES REQUIRE 2 WEEK LEAD TIME**



## 3" Picket - 60", 72" High

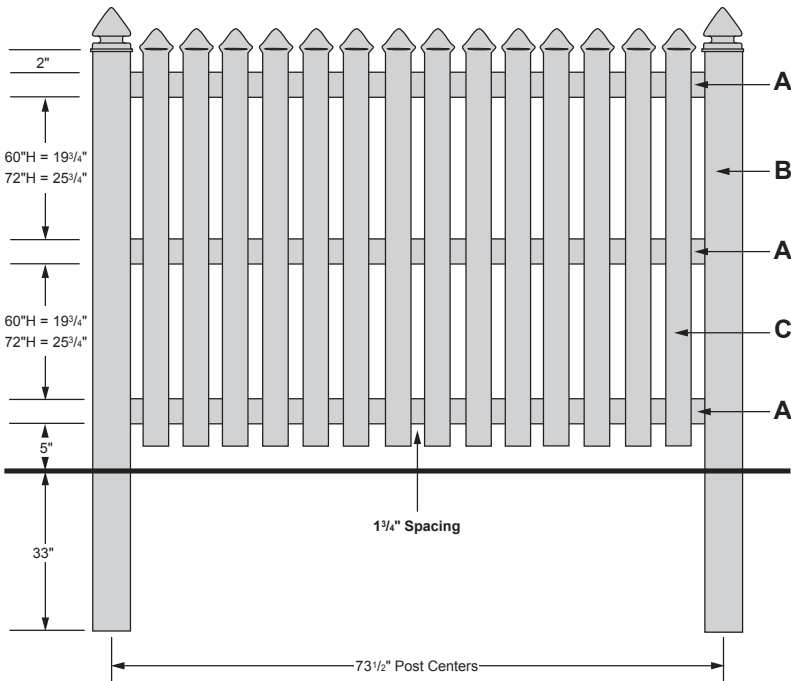

- A - 2" x 4" x 71½" Drilled Rails
- B - 5" x 5" Posts  
60" High = 90" Post Length  
72" High = 102" Post Length
- C - (14) 7/8" x 3" Pre-Drilled Pickets  
60" High = 58" Long Pickets  
72" High = 70" Long Pickets

### Product Information (6' Sections)

3" x 60", 72" High Deluxe Straight Picket Fence. All sections include 1-post per section, additional posts available, see price sheet.



60", 72" available to meet pool code.

**Sections under or over 6' long - 15% extra for special fabrication**  
**Colors Available - White, (Ivory & Gray - 15% Extra)**

---

---

# Deluxe Straight Picket Fence - Gates

---

---

## 3" Picket Shown Below

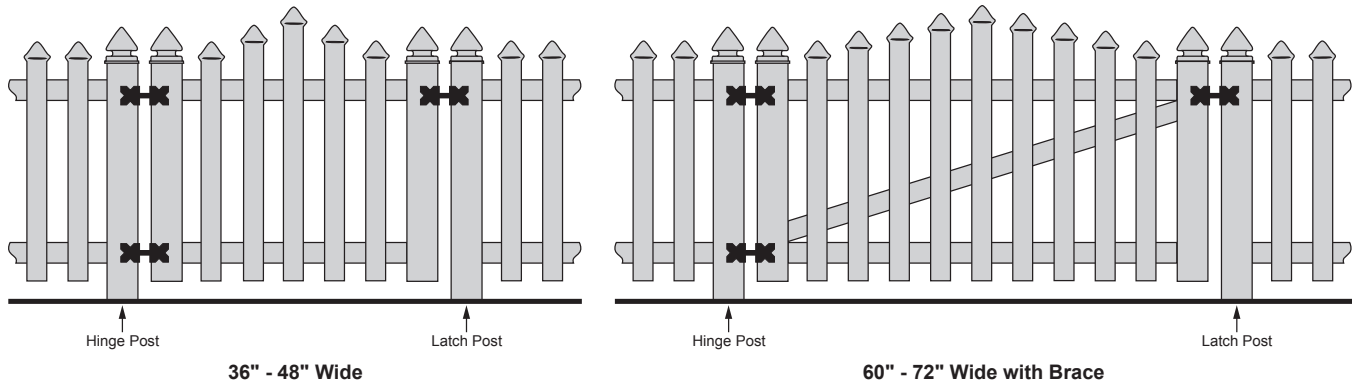

### 36" - 48" High

#### Hardware Recommended:

- Single Gates: 1- residential hinge set  
1- residential latch or 2-way latch set  
1- 4" aluminum post insert (*hinge post*)
- Double Gates: 2- residential hinge set  
1- residential latch or 2-way latch set  
1- residential drop pin kit  
2- 4" aluminum post insert (*hinge post*)

### 60" - 72" High

#### Hardware Recommended:

- Single Gates: 1- commercial hinge set  
1- commercial latch or 2-way latch set  
1- 5" aluminum post insert (*hinge post*)
- Double Gates: 2- commercial hinge set  
1- commercial latch or 2-way latch set  
1- commercial drop pin kit  
2- 5" aluminum post insert (*hinge post*)

---

---

# Deluxe Straight Picket Fence - Gates

---

---



1 1/2" Picket Shown Below

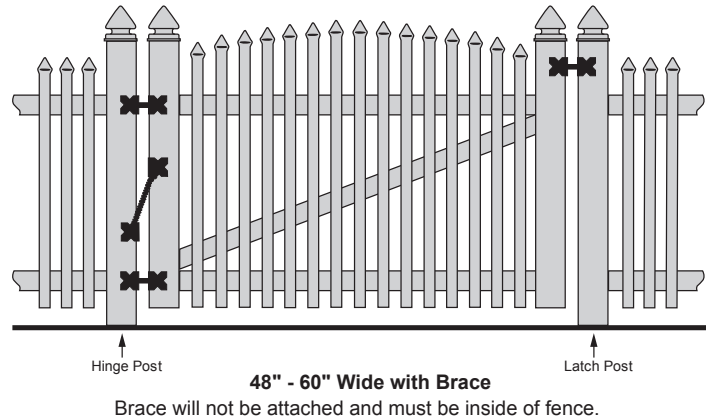
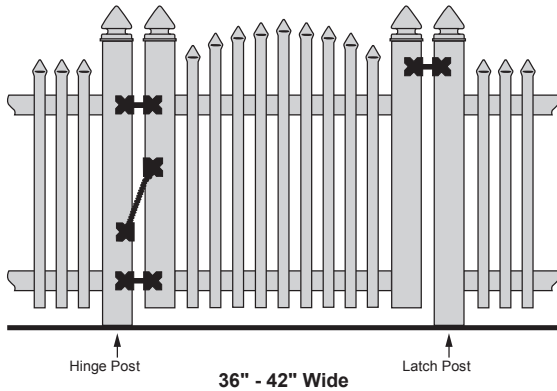

## 48" High

### Hardware Recommended:

- Single Gates: 1- residential hinge set  
1- residential latch or 2-way latch set  
1- 4" aluminum post insert (*hinge post*)  
1- residential spring set (*must have!*)
- Double Gates: 2- residential hinge set  
1- residential latch or 2-way latch set  
1- residential drop pin kit  
2- 4" aluminum post insert (*hinge post*)  
2- residential spring sets (*must have!*)

## 60" - 72" High

### Hardware Recommended:

- Single Gates: 1- commercial hinge set  
1- commercial latch or 2-way latch set  
1- 5" aluminum post insert (*hinge post*)  
1- commercial spring set (*must have!*)
- Double Gates: 2- commercial hinge set  
1- commercial latch or 2-way latch set  
1- commercial drop pin kit  
2- 5" aluminum post insert (*hinge post*)  
2- commercial spring sets (*must have!*)



**Note: bottom of gate latch must be 54" from ground level!**

# Deluxe Concave Picket Fence

**New!**  
**4"x4" Post**

## 1 1/2" Picket - 36", 48" High (Measurements taken at low point)

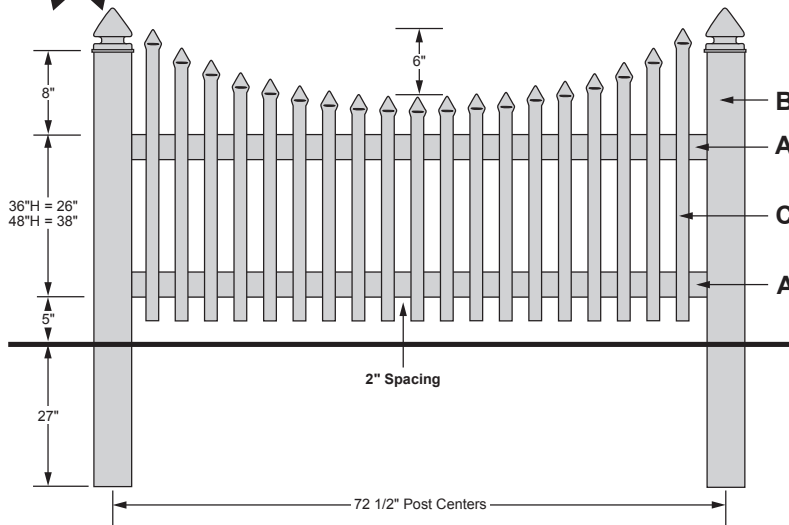

A - 2" x 4" x 71 1/2" Drilled Rails

B - 4" x 4" Posts  
36" High = 66" Post Length  
48" High = 82" Post Length

C - (19) 7/8" x 1 1/2" Pre-Drilled & Numbered Pickets  
36" High = 34" Short Pickets  
40" Long Pickets  
48" High = 46" Short Pickets  
52" Long Pickets



**POOL CODE STYLES REQUIRE 2 WEEK LEAD TIME**



## 1 1/2" Picket - 48" High (Measurements taken at low point)

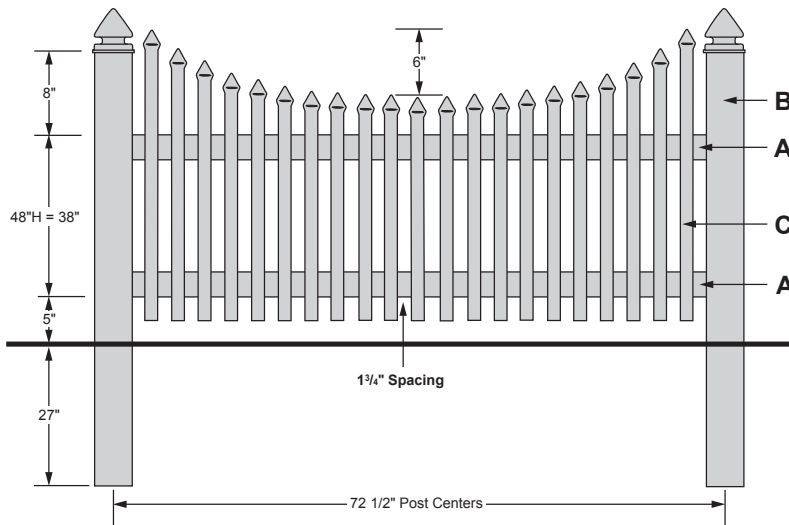

A - 2" x 4" x 71 1/2" Drilled Rails

B - 4" x 4" Posts  
48" High = 82" Post Length

C - (21) 7/8" x 1 1/2" Pre-Drilled & Numbered Pickets  
48" High = 46" Short Pickets  
52" Long Pickets

### Product Information (6' Sections)

1 1/2" x 36", 48" High Deluxe Concave Picket fence. All sections include 1-post per section, additional posts available, see price sheet.



48" available to meet pool code.

Sections under or over 6' long - 15% extra for special fabrication  
Colors Available - White, (Ivory & Gray - 15% Extra)

# Deluxe Concave Picket Fence

## 3" Picket - 36", 48" High (Measurements taken at low point)

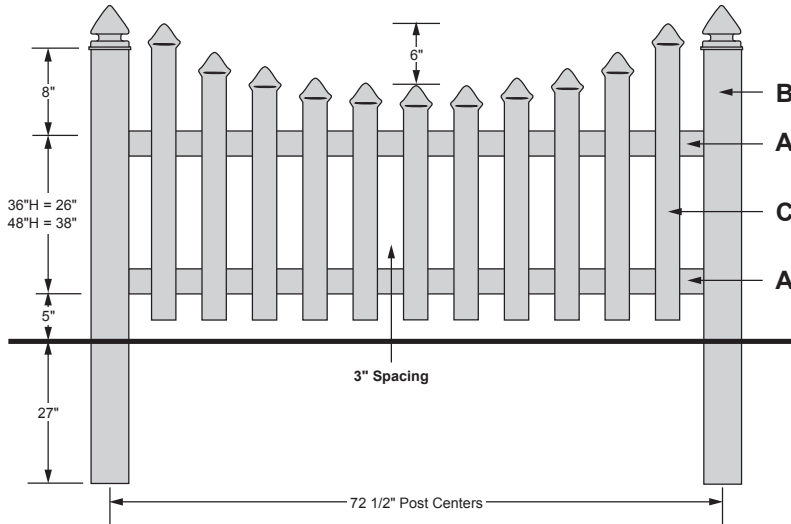

A - 2" x 4" x 71½" Drilled Rails

B - 4" x 4" Posts  
36" High = 66" Post Length  
48" High = 82" Post Length

C - (11) 7/8" x 3" Pre-Drilled & Numbered Pickets  
36" High = 34" Short Pickets  
40" Long Pickets  
48" High = 46" Short Pickets  
52" Long Pickets



**POOL CODE STYLES REQUIRE 2 WEEK LEAD TIME**



## 3" Picket - 48" High (Measurements taken at low point)

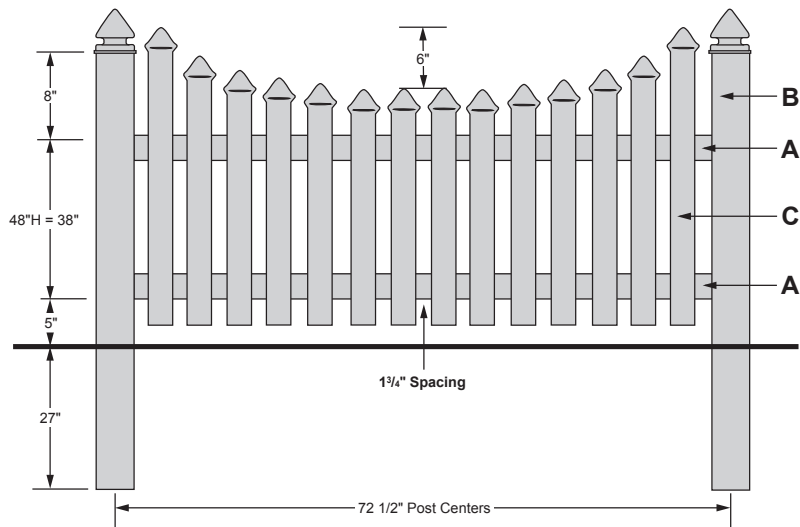

A - 2" x 4" x 71½" Drilled Rails

B - 4" x 4" Posts  
48" High = 82" Post Length

C - (14) 7/8" x 3" Pre-Drilled & Numbered Pickets  
48" High = 46" Short Pickets  
52" Long Pickets

### Product Information (6' Sections)

3" x 36", 48" High Deluxe Concave Picket fence. All sections include 1-post per section, additional posts available, see price sheet.



48" available to meet pool code.

Sections under or over 6' long - 15% extra for special fabrication  
Colors Available - White, (Ivory & Gray - 15% Extra)

# Deluxe Concave Picket Fence

## 1 1/2" Picket - 60", 72" High (Measurements taken at low point)

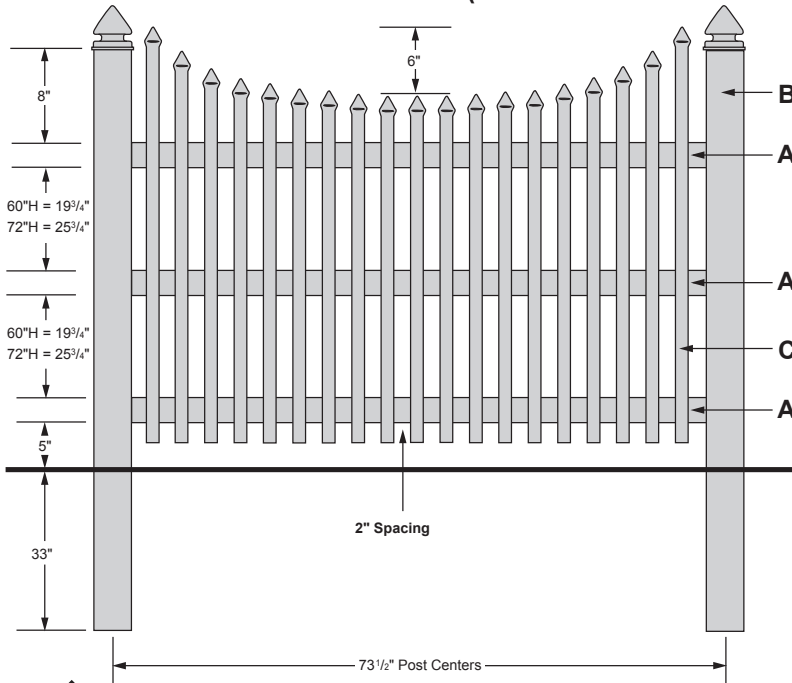

A - 2" x 4" x 71 1/2" Drilled Rails

B - 5" x 5" Posts  
60" High = 96" Post Length  
72" High = 107" Post Length

C - (19) 7/8" x 1 1/2" Pre-Drilled & Numbered Pickets  
60" High = 58" Short Pickets  
64" Long Pickets  
72" High = 70" Short Pickets  
76" Long Pickets



**POOL CODE STYLES REQUIRE 2 WEEK LEAD TIME**



## 1 1/2" Picket - 60", 72" High (Measurements taken at low point)

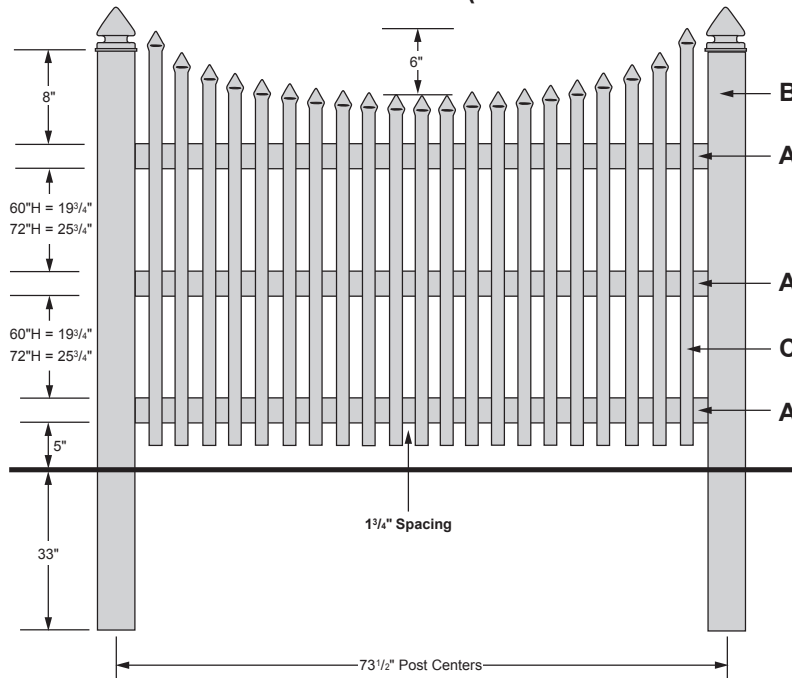

A - 2" x 4" x 71 1/2" Drilled Rails

B - 5" x 5" Posts  
60" High = 96" Post Length  
72" High = 107" Post Length

C - (21) 7/8" x 1 1/2" Pre-Drilled & Numbered Pickets  
60" High = 58" Short Pickets  
64" Long Pickets  
72" High = 70" Short Pickets  
76" Long Pickets

### Product Information (6' Sections)

1 1/2" x 60", 72" High Deluxe Concave Picket fence. All sections include 1-post per section, additional posts available, see price sheet.



60", 72" available to meet pool code.

Sections under or over 6' long - 15% extra for special fabrication  
Colors Available - White, (Ivory & Gray - 15% Extra)

# Deluxe Concave Picket Fence

## 3" Picket - 60", 72" High (Measurements taken at low point)

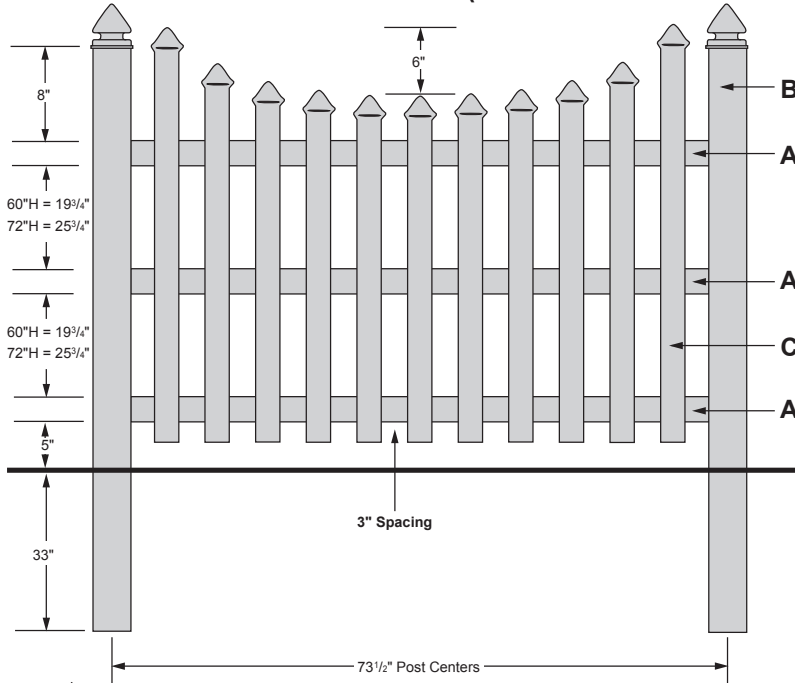

- A - 2" x 4" x 71½" Drilled Rails
- B - 5" x 5" Posts  
60" High = 96" Post Length  
72" High = 107" Post Length
- C - (11) 7/8" x 3" Pre-Drilled & Numbered Pickets  
60" High = 58" Short Pickets  
64" Long Pickets  
72" High = 70" Short Pickets  
76" Long Pickets



**POOL CODE STYLES REQUIRE 2 WEEK LEAD TIME**



## 3" Picket - 60", 72" High (Measurements taken at low point)

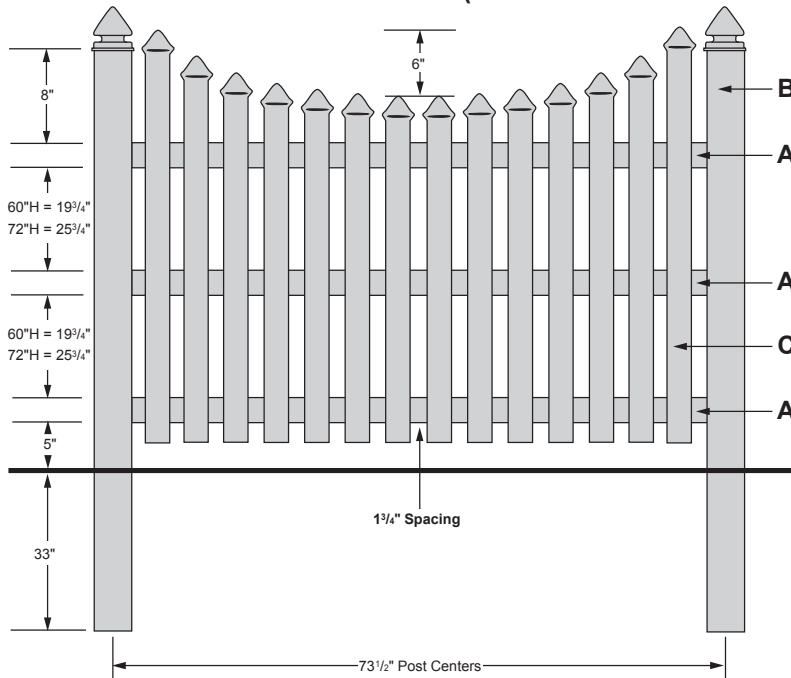

- A - 2" x 4" x 71½" Drilled Rails
- B - 5" x 5" Posts  
60" High = 96" Post Length  
72" High = 107" Post Length
- C - (14) 7/8" x 3" Pre-Drilled & Numbered Pickets  
60" High = 58" Short Pickets  
64" Long Pickets  
72" High = 70" Short Pickets  
76" Long Pickets

### Product Information (6' Sections)

3" x 60", 72" High Deluxe Concave Picket fence. All sections include 1-post per section, additional posts available, see price sheet.



60", 72" available to meet pool code.

Sections under or over 6' long - 15% extra for special fabrication  
Colors Available - White, (Ivory & Gray - 15% Extra)

---

---

# Deluxe Concave Picket Fence - Gates

---

---

1½" Picket Shown Below

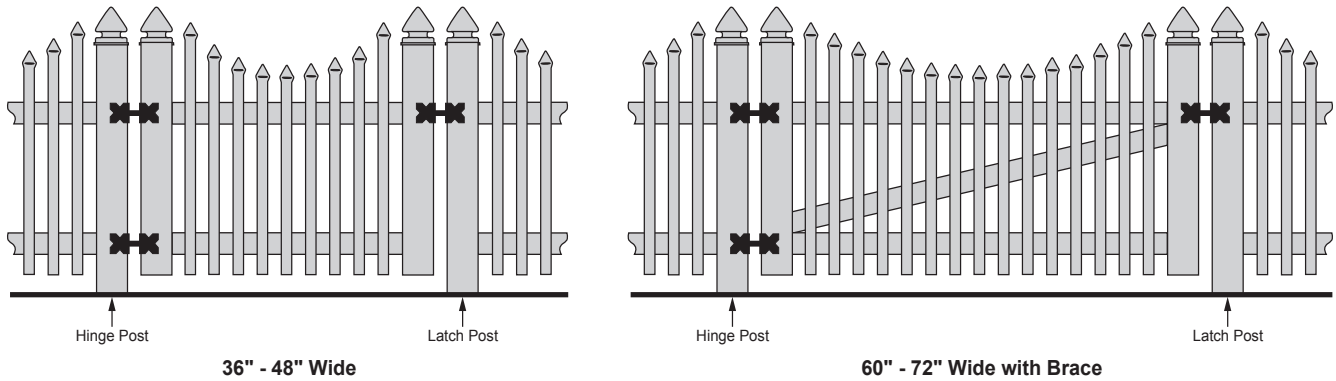

**36" - 48" High**

**Hardware Recommended:**

- Single Gates: 1- residential hinge set  
1- residential latch or 2-way latch set  
1- 4" aluminum post insert (*hinge post*)
- Double Gates: 2- residential hinge set  
1- residential latch or 2-way latch set  
1- residential drop pin kit  
2- 4" aluminum post insert (*hinge post*)

**60" - 72" High**

**Hardware Recommended:**

- Single Gates: 1- commercial hinge set  
1- commercial latch or 2-way latch set  
1- 5" aluminum post insert (*hinge post*)
- Double Gates: 2- commercial hinge set  
1- commercial latch or 2-way latch set  
1- commercial drop pin kit  
2- 5" aluminum post insert (*hinge post*)

---

---

# Deluxe Concave Picket Fence - Gates

---

---



1 1/2" Picket Shown Below

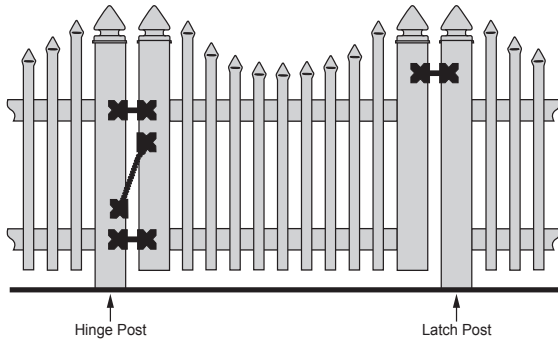

36" - 42" Wide

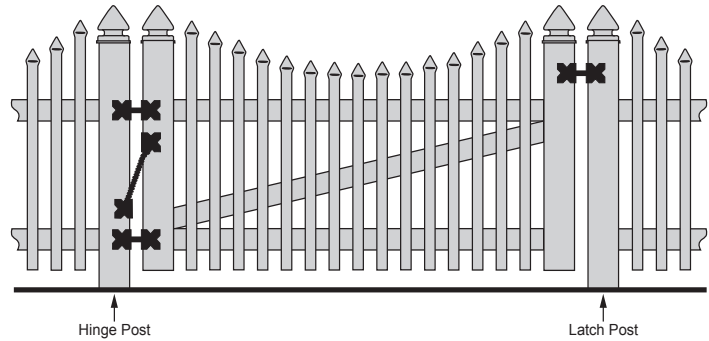

48" - 60" Wide with Brace

Brace will not be attached and must be inside of fence.

## 48" High

### Hardware Recommended:

- Single Gates: 1- residential hinge set  
1- residential latch or 2-way latch set  
1- 4" aluminum post insert (*hinge post*)  
1- residential spring set (*must have!*)
- Double Gates: 2- residential hinge set  
1- residential latch or 2-way latch set  
1- residential drop pin kit  
2- 4" aluminum post insert (*hinge post*)  
2- residential spring sets (*must have!*)

## 60" - 72" High

### Hardware Recommended:

- Single Gates: 1- commercial hinge set  
1- commercial latch or 2-way latch set  
1- 5" aluminum post insert (*hinge post*)  
1- commercial spring set (*must have!*)
- Double Gates: 2- commercial hinge set  
1- commercial latch or 2-way latch set  
1- commercial drop pin kit  
2- 5" aluminum post insert (*hinge post*)  
2- commercial spring sets (*must have!*)



**Note: bottom of gate latch must be 54" from ground level!**

# Recommended Sketch Drawing For Fence

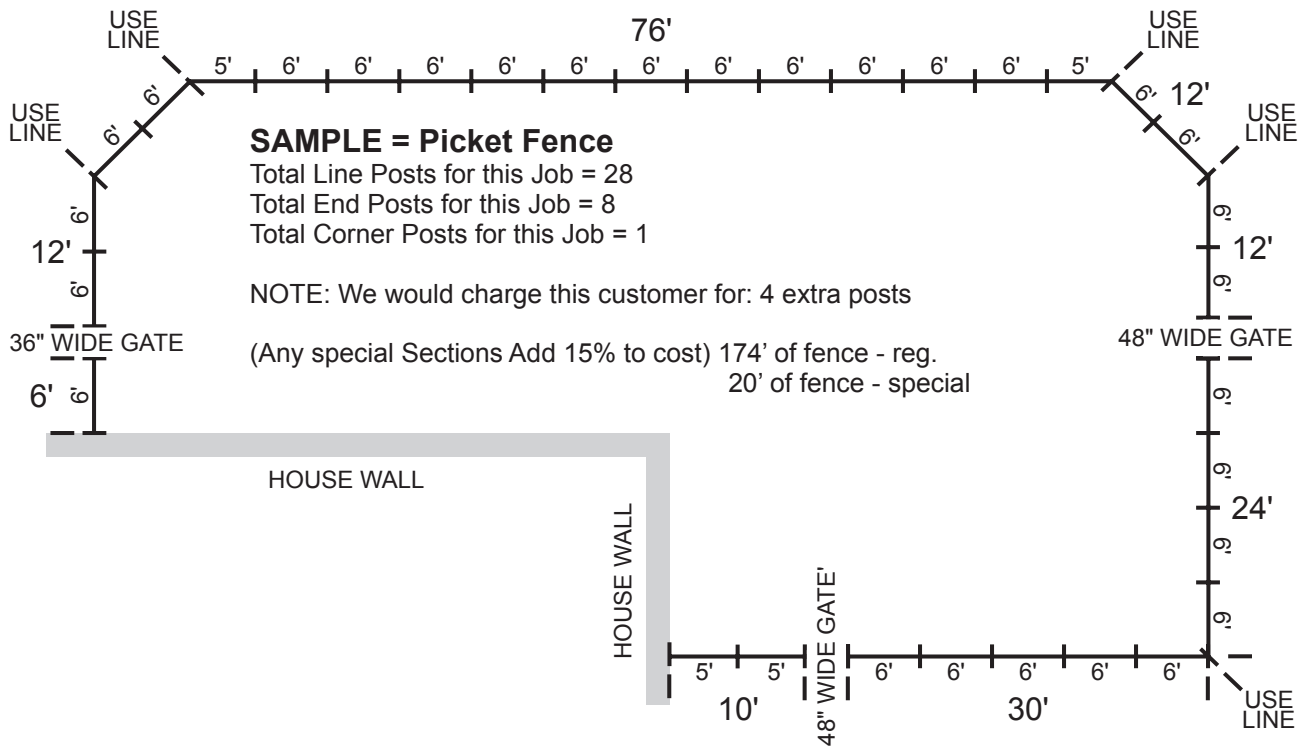

NOTE: Post Spacing Differs on Styles of Fence

## ***Answers Needed for These Questions:***

- Height of Fence? \_\_\_\_\_
- Style of Fence? \_\_\_\_\_
- How Many Line Posts? \_\_\_\_\_
- How Many End Posts? \_\_\_\_\_
- How Many Corner Posts? \_\_\_\_\_
- What Style Caps? \_\_\_\_\_
- Width of Each Gate? \_\_\_\_\_
- How Many Hinges? \_\_\_\_\_
- How Many Latches? \_\_\_\_\_
- How Many Drop Pin Kits? \_\_\_\_\_
- How Many Post Inserts? \_\_\_\_\_

---

# Deluxe and Denmark Picket Fence Installation Instructions

---

## Step 1: Preparation and Digging

First, set stakes and stretch your line. Use spray paint to mark location of holes. Holes should be 28" deep and should be 72½" on center. We recommend a 9" hole auger.

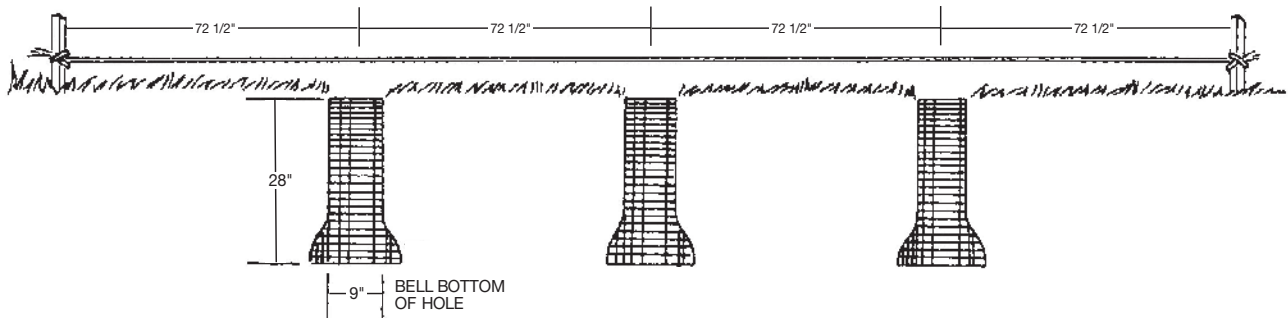

**Note:** 5' and 6' high fence are 73½" center to center and use a 12" hole auger.

## Step 2: Aligning of Fence Post

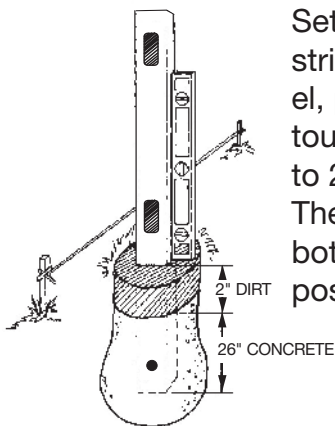

Set corner and end post and mark on string for 72½" centers. Using a 4' level, position post close to string without touching. When post is plumb, fill hole to 2" below ground level with concrete. Then fill the rest with dirt. Be sure that bottom of the routed hole on fence post is 5" above ground.

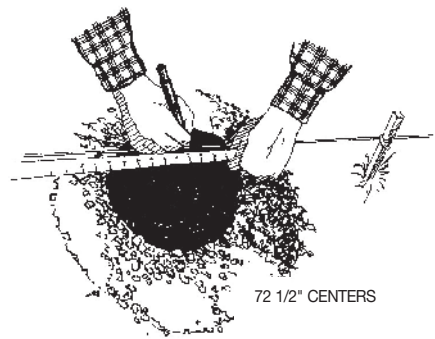

For ease of installation, mark your level where top of post should be allowing for 5" spacing of bottom routed hole, keeping your level on the ground.

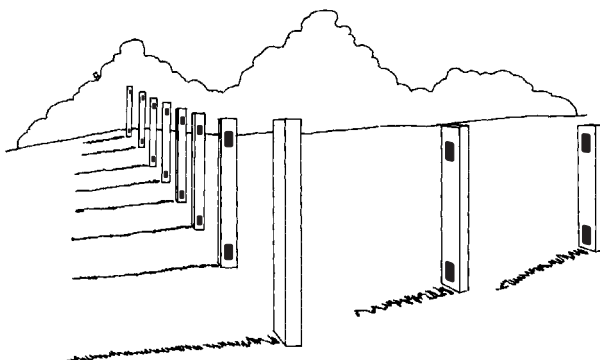

After all posts are in, sight across top of posts to ensure posts follow the contour of the land. Adjust posts accordingly and check for plumb by sighting down the side of the posts. Allow posts to set over-night before installing sections.

Follow contour of land and avoid choppy up and down look.

# Deluxe and Denmark Picket Fence Installation Instructions

## Step 3: Gate Post Installation

4" Posts: "Standard"™ Residential and "Select"™ Hardware. Single Gate opening should be 2" wider than gate. Double Gate opening should be 3" wider than gate.

5" Posts: "Standard"™ Commercial Hardware. Single Gate opening should be 3" wider than gate. Double Gate opening should be 4½" wider than gate.

Slip aluminum post insert into PVC post before inserting rails into posts.

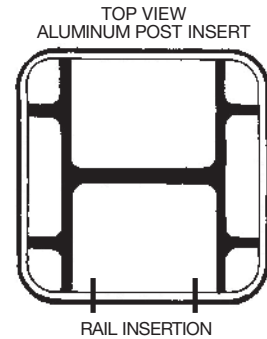
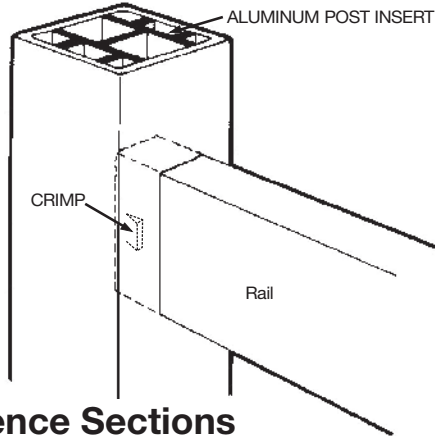

Note: Make sure the wide part of the Aluminum insert is facing toward the holes in post.

## Step 4: Installing Fence Sections

Insert 2 x 4 rails into post. Insert screws into pre-drilled holes and then with electric drill affix pickets to rails being sure to insert screws into guide holes on pickets. Finish by gluing post caps on.

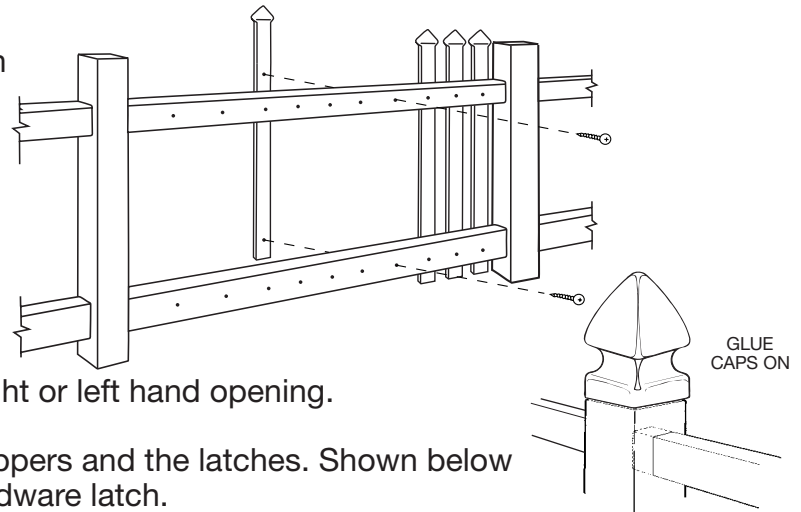

**Note: Gate springs available. Gate springs must be used for (2-way latch available for 4" posts)**



## Step 5: Installation of Gate

The gate hardware can be used for a right or left hand opening.

It simply is a matter of reversing the clappers and the latches. Shown below is the proper positioning of the gate hardware latch.

Bottom of latch must be 54" from ground level for

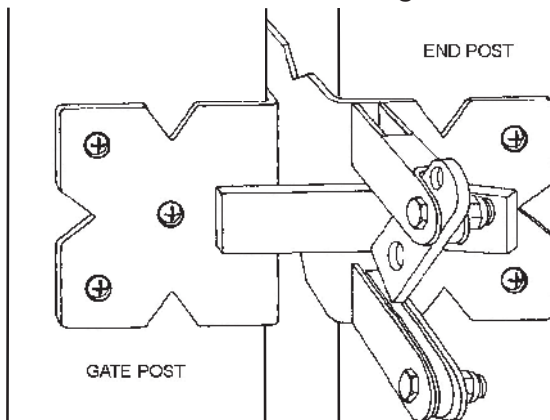

Note: Looks best when hinges line up with horizontal rails.

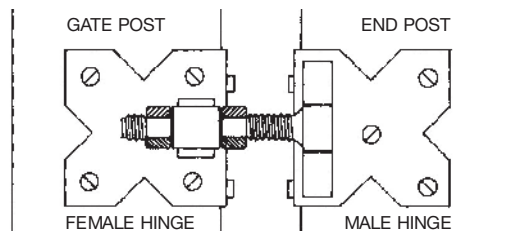

Hinges should be installed as such: the male hinge is mounted on the end post and has adjustable nuts to compensate for opening. The female hinge is mounted on the gate itself.