

Denmark Straight Picket Fence

New!
4"x4"
Post

3" Picket - 36", 48" High

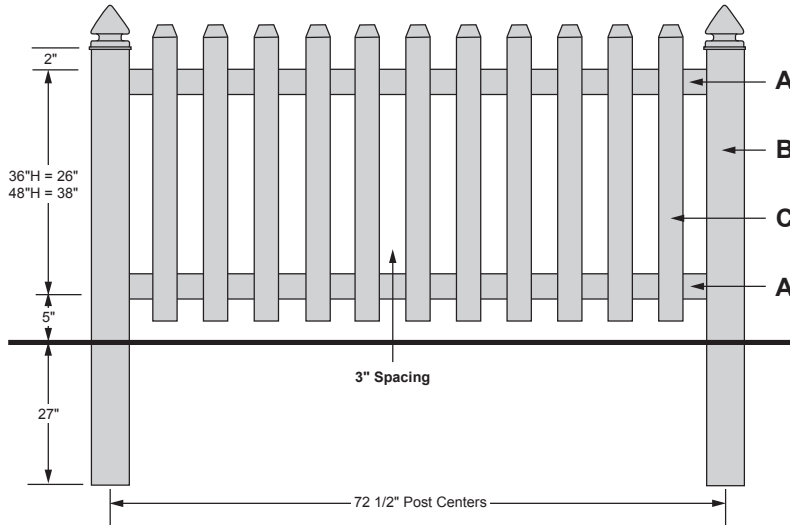

A - 2" x 4" x 71½" Drilled Rails

B - 4" x 4" Posts

36" High = 60" Post Length

48" High = 72" Post Length

C - (11) 7/8" x 3" Pre-Drilled Pickets

36" High = 34" Long Pickets

48" High = 46" Long Pickets



POOL CODE STYLES REQUIRE 2 WEEK LEAD TIME



3" Picket - 48" High

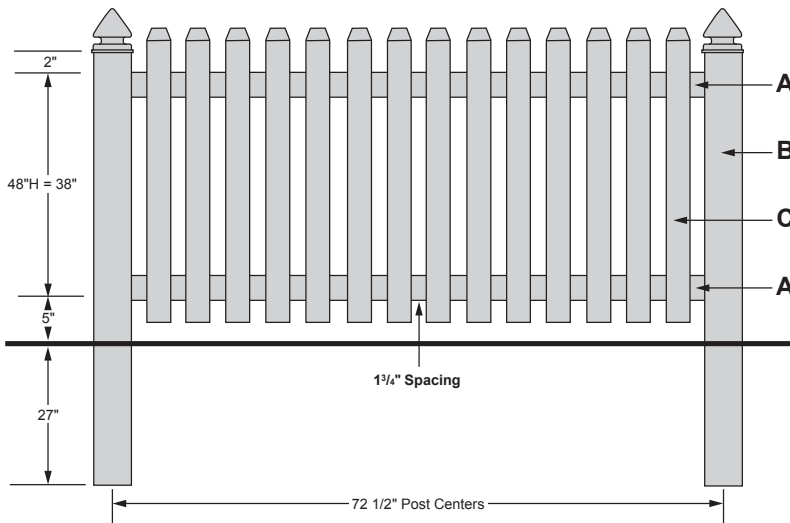

A - 2" x 4" x 71½" Drilled Rails

B - 4" x 4" Posts

48" High = 72" Post Length

C - (14) 7/8" x 3" Pre-Drilled Pickets

48" High = 46" Long Pickets

Product Information (6' Sections)

3" x 36", 48" High Denmark Straight Picket Fence. All sections include 1-post per section, additional posts available, see price sheet.



48" available to meet pool code.

Sections under or over 6' long - 15% extra for special fabrication
Colors Available - White, (Ivory & Gray - 15% Extra)

Denmark Straight Picket Fence

3" Picket - 60", 72" High

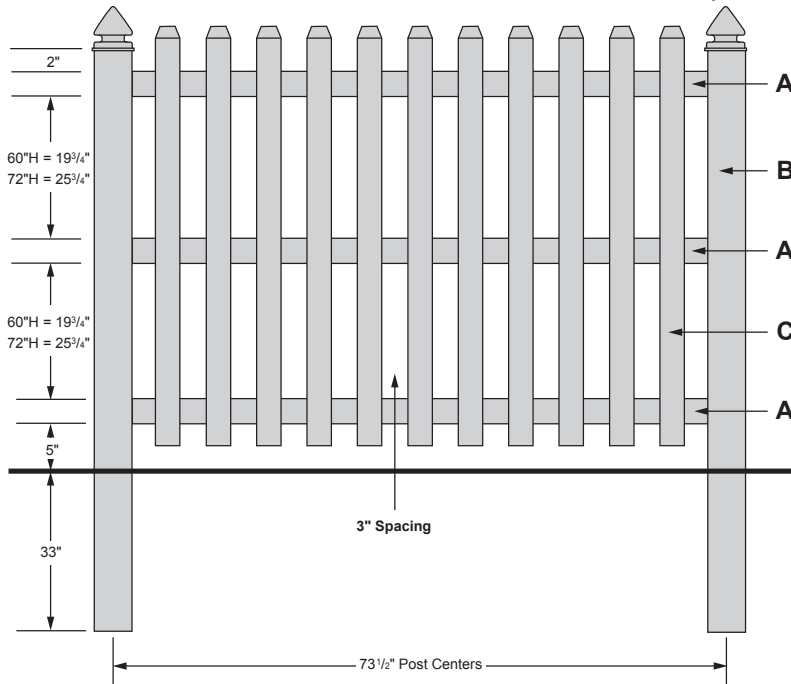

A - 2" x 4" x 71½" Drilled Rails

B - 5" x 5" Posts
60" High = 90" Post Length
72" High = 102" Post Length

C - (11) 7/8" x 3" Pre-Drilled Pickets
60" High = 58" Long Pickets
72" High = 70" Long Pickets



POOL CODE STYLES REQUIRE 2 WEEK LEAD TIME



3" Picket - 60", 72" High

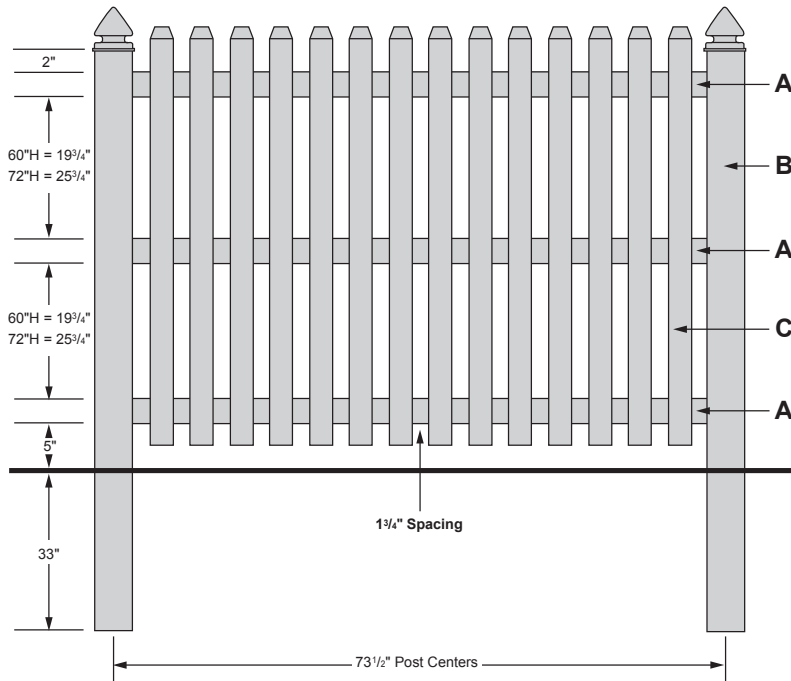

A - 2" x 4" x 71½" Drilled Rails

B - 5" x 5" Posts
60" High = 90" Post Length
72" High = 102" Post Length

C - (14) 7/8" x 3" Pre-Drilled Pickets
60" High = 58" Long Pickets
72" High = 70" Long Pickets

Product Information (6' Sections)

3" x 60", 72" High Denmark Straight Picket Fence. All sections include 1-post per section, additional posts available, see price sheet.



60", 72" available to meet pool code.

Sections under or over 6' long - 15% extra for special fabrication
Colors Available - White, (Ivory & Gray - 15% Extra)

Denmark Straight Picket Fence - Gates

3" Picket Shown Below

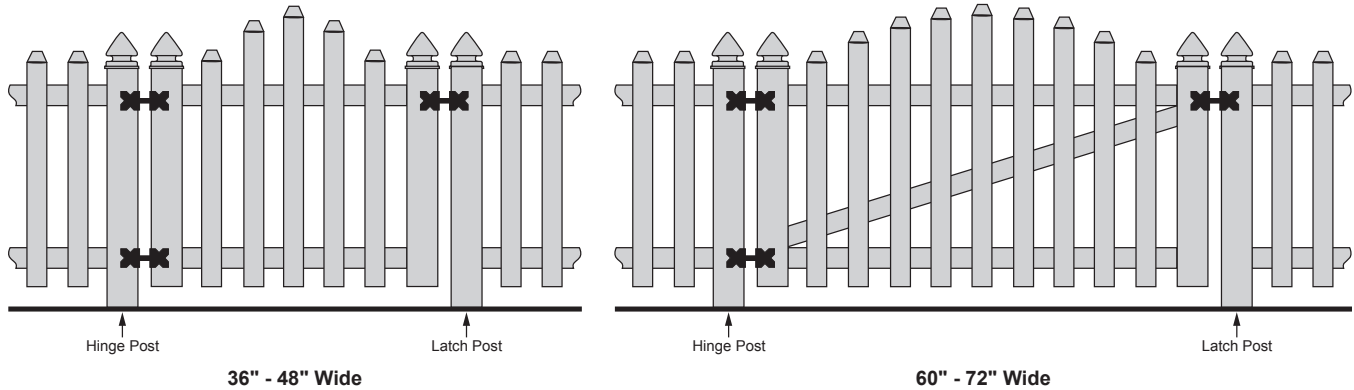

36\" - 48\" High Hardware Recommended:

- Single Gates: 1- residential hinge set
1- residential latch or 2-way latch set
1- 4\" aluminum post insert (*hinge post*)
- Double Gates: 2- residential hinge set
1- residential latch or 2-way latch set
1- residential drop pin kit
2- 4\" aluminum post insert (*hinge post*)

60\" - 72\" High Hardware Recommended:

- Single Gates: 1- commercial hinge set
1- commercial latch or 2-way latch set
1- 5\" aluminum post insert (*hinge post*)
- Double Gates: 2- commercial hinge set
1- commercial latch or 2-way latch set
1- commercial drop pin kit
2- 5\" aluminum post insert (*hinge post*)

Denmark Straight Picket Fence - Gates



3" Picket Shown Below

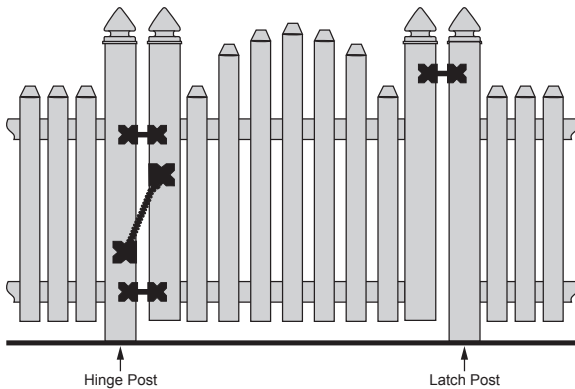

36" - 48" Wide

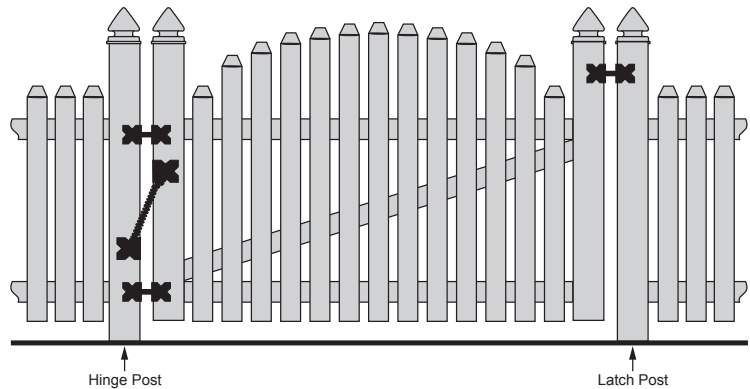

60" - 72" Wide with Brace

Brace will not be attached and must be inside of fence.

36" - 48" High Hardware Recommended:

- Single Gates: 1- residential hinge set
1- residential latch or 2-way latch set
1- 4" aluminum post insert (*hinge post*)
1- residential spring set (*must have!*)
- Double Gates: 2- residential hinge set
1- residential latch or 2-way latch set
1- residential drop pin kit
2- 4" aluminum post insert (*hinge post*)
2- residential spring set (*must have!*)

60" - 72" High Hardware Recommended:

- Single Gates: 1- commercial hinge set
1- commercial latch or 2-way latch set
1- 5" aluminum post insert (*hinge post*)
1- commercial spring set (*must have!*)
- Double Gates: 2- commercial hinge set
1- commercial latch or 2-way latch set
1- commercial drop pin kit
2- 5" aluminum post insert (*hinge post*)
2- commercial spring set (*must have!*)



Note: bottom of gate latch must be 54" from ground level!

Denmark Concave Picket Fence

New!
4"x4"
Post

3" Picket - 36", 48" High (Measurements taken at low point)

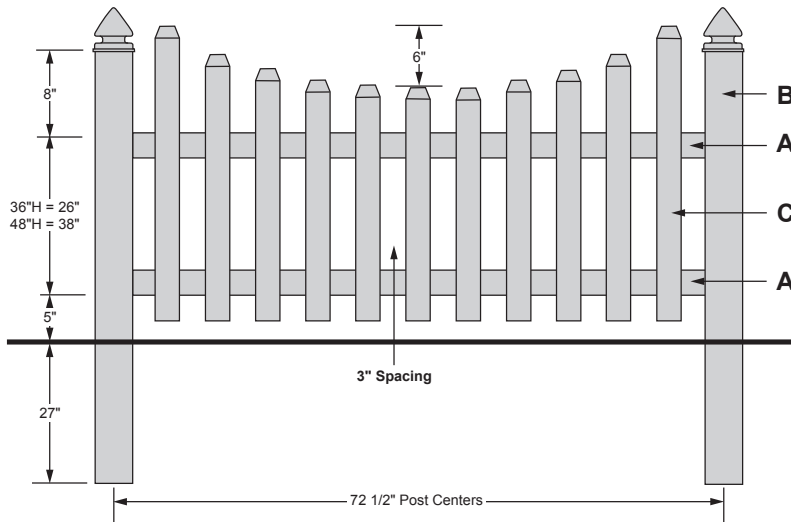

A - 2" x 4" x 71½" Drilled Rails

B - 4" x 4" Posts
36" High = 66" Post Length
48" High = 82" Post Length

C - (11) 7/8" x 3" Pre-Drilled & Numbered Pickets
36" High = 34" Short Pickets
40" Long Pickets
48" High = 46" Short Pickets
52" Long Pickets



POOL CODE STYLES REQUIRE 2 WEEK LEAD TIME



3" Picket - 48" High (Measurements taken at low point)

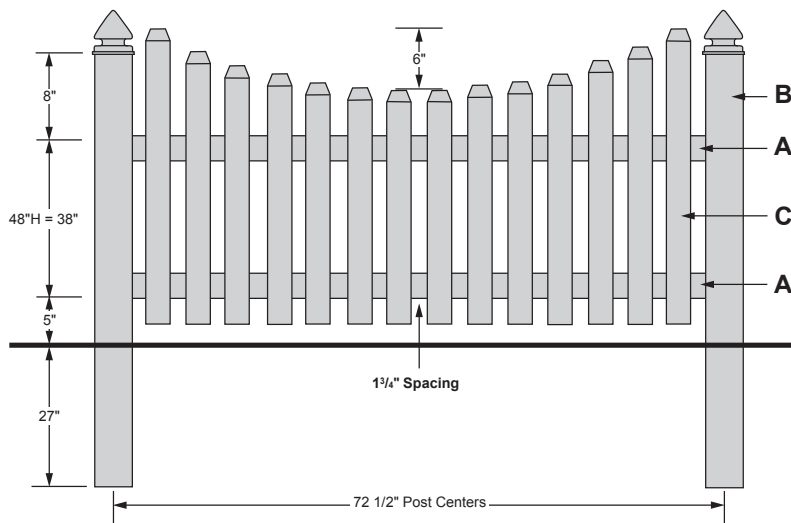

A - 2" x 4" x 71½" Drilled Rails

B - 4" x 4" Posts
48" High = 82" Post Length

C - (14) 7/8" x 3" Pre-Drilled & Numbered Pickets
48" High = 46" Short Pickets
52" Long Pickets

Product Information (6' Sections)

3" x 36", 48" High Denmark Concave Picket fence. All sections include 1-post per section, additional posts available, see price sheet.



48" available to meet pool code.

Sections under or over 6' long - 15% extra for special fabrication
Colors Available - White, (Ivory & Gray - 15% Extra)

Denmark Concave Picket Fence

3" Picket - 60", 72" High (Measurements taken at low point)

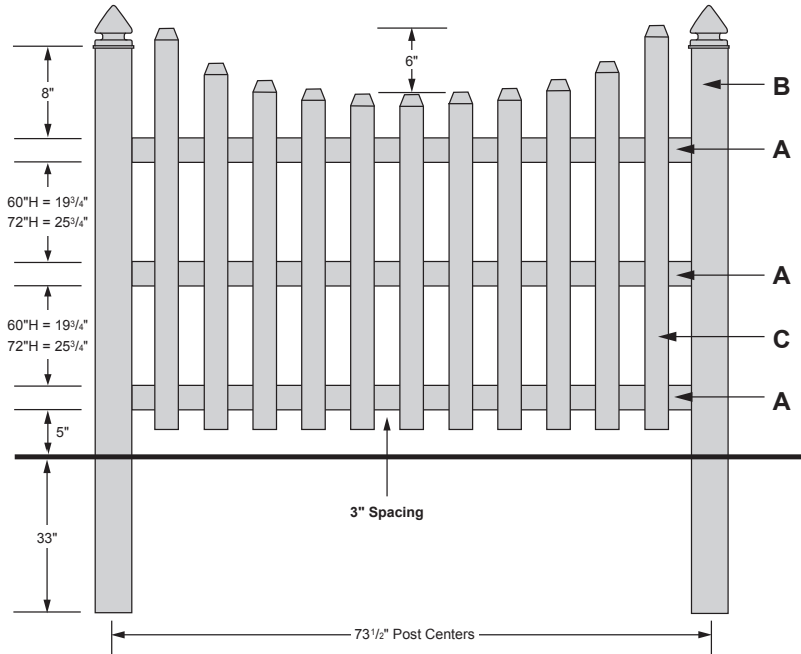

A - 2" x 4" x 7 1/2" Drilled Rails

B - 5" x 5" Posts
60" High = 96" Post Length
72" High = 107" Post Length

C - (11) 7/8" x 3" Pre-Drilled & Numbered Pickets
60" High = 58" Short Pickets
64" Long Pickets
72" High = 70" Short Pickets
76" Long Pickets



POOL CODE STYLES REQUIRE 2 WEEK LEAD TIME



3" Picket - 60", 72" High (Measurements taken at low point)

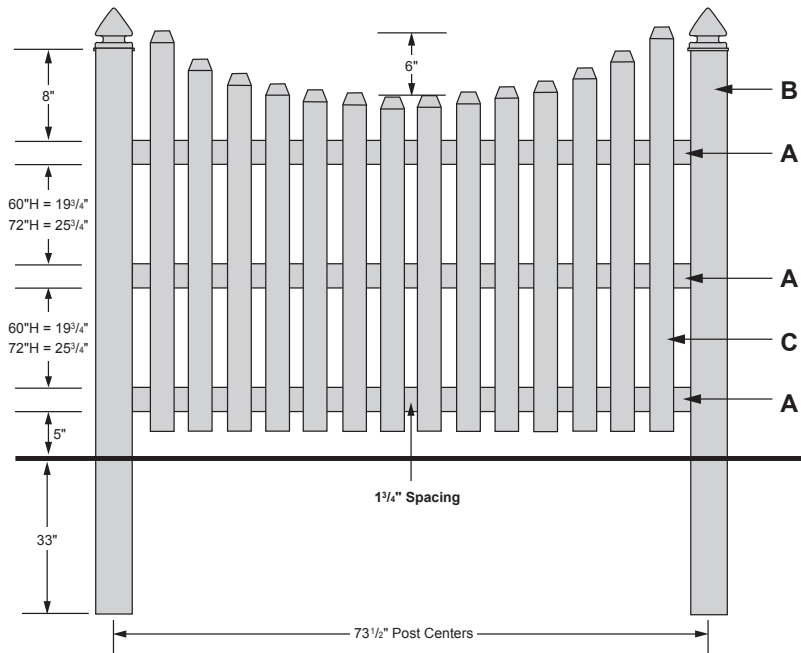

A - 2" x 4" x 7 1/2" Drilled Rails

B - 5" x 5" Posts
60" High = 96" Post Length
72" High = 107" Post Length

C - (14) 7/8" x 3" Pre-Drilled & Numbered Pickets
60" High = 58" Short Pickets
64" Long Pickets
72" High = 70" Short Pickets
76" Long Pickets

Product Information (6' Sections)

3" x 60", 72" High Denmark Concave Picket fence. All sections include 1-post per section, additional posts available, see price sheet.



60", 72" available to meet pool code.

Sections under or over 6' long - 15% extra for special fabrication
Colors Available - White, (Ivory & Gray - 15% Extra)

Denmark Concave Picket Fence - Gates

3" Picket Shown Below

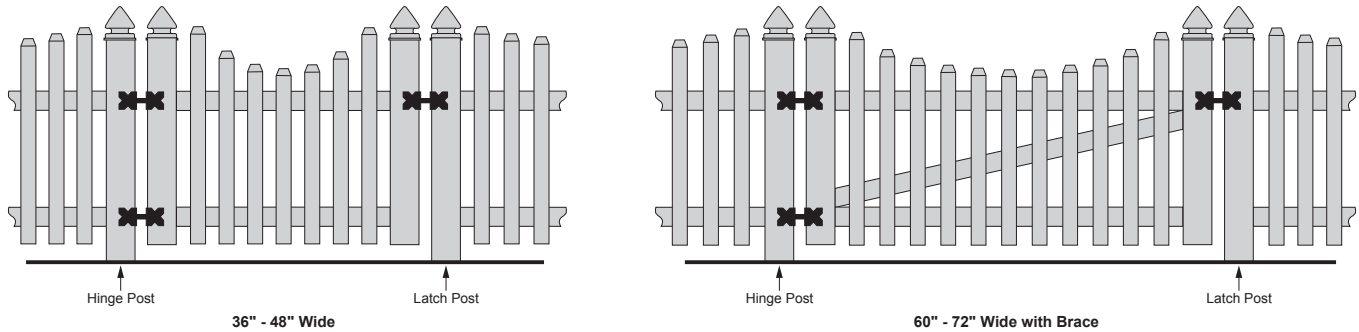

36" - 48"

High Hardware Recommended:

- Single Gates: 1- residential hinge set
1- residential latch or 2-way latch set
1- 4" aluminum post insert (*hinge post*)
- Double Gates: 2- residential hinge set
1- residential latch or 2-way latch set
1- residential drop pin kit
2- 4" aluminum post insert (*hinge post*)

60" - 72"

High Hardware Recommended:

- Single Gates: 1- commercial hinge set
1- commercial latch or 2-way latch set
1- 5" aluminum post insert (*hinge post*)
- Double Gates: 2- commercial hinge set
1- commercial latch or 2-way latch set
1- commercial drop pin kit
2- 5" aluminum post insert (*hinge post*)

Denmark Concave Picket Fence - Gates



3" Picket Shown Below

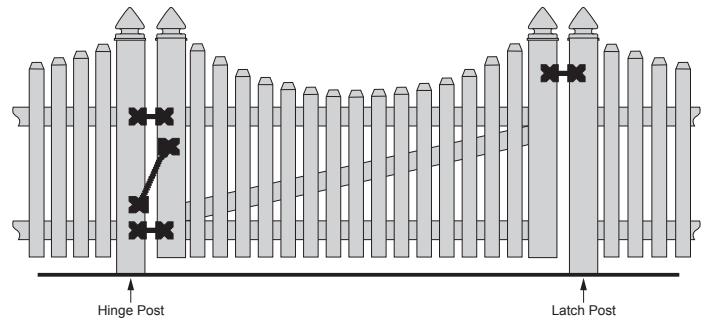
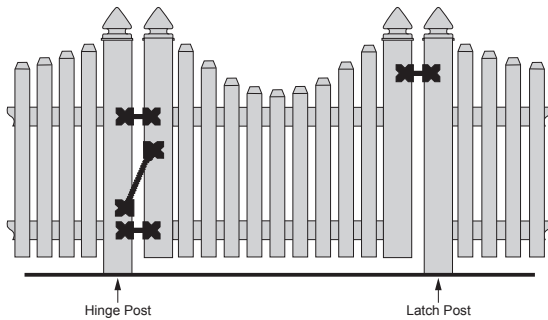

36" - 48" High

Hardware Recommended:

- Single Gates: 1- residential hinge set
1- residential latch or 2-way latch set
1- 4" aluminum post insert (*hinge post*)
1- residential spring set (*must have!*)
- Double Gates: 2- residential hinge set
1- residential latch or 2-way latch set
1- residential drop pin kit
2- 4" aluminum post insert (*hinge post*)
1- residential spring set (*must have!*)

60" - 72" High

Hardware Recommended:

- Single Gates: 1- commercial hinge set
1- commercial latch or 2-way latch set
1- 5" aluminum post insert (*hinge post*)
1- commercial spring set (*must have!*)
- Double Gates: 2- commercial hinge set
1- commercial latch or 2-way latch set
1- commercial drop pin kit
2- 5" aluminum post insert (*hinge post*)
2- commercial spring set (*must have!*)



Note: bottom of gate latch must be 54" from ground level!

Recommended Sketch Drawing For Fence

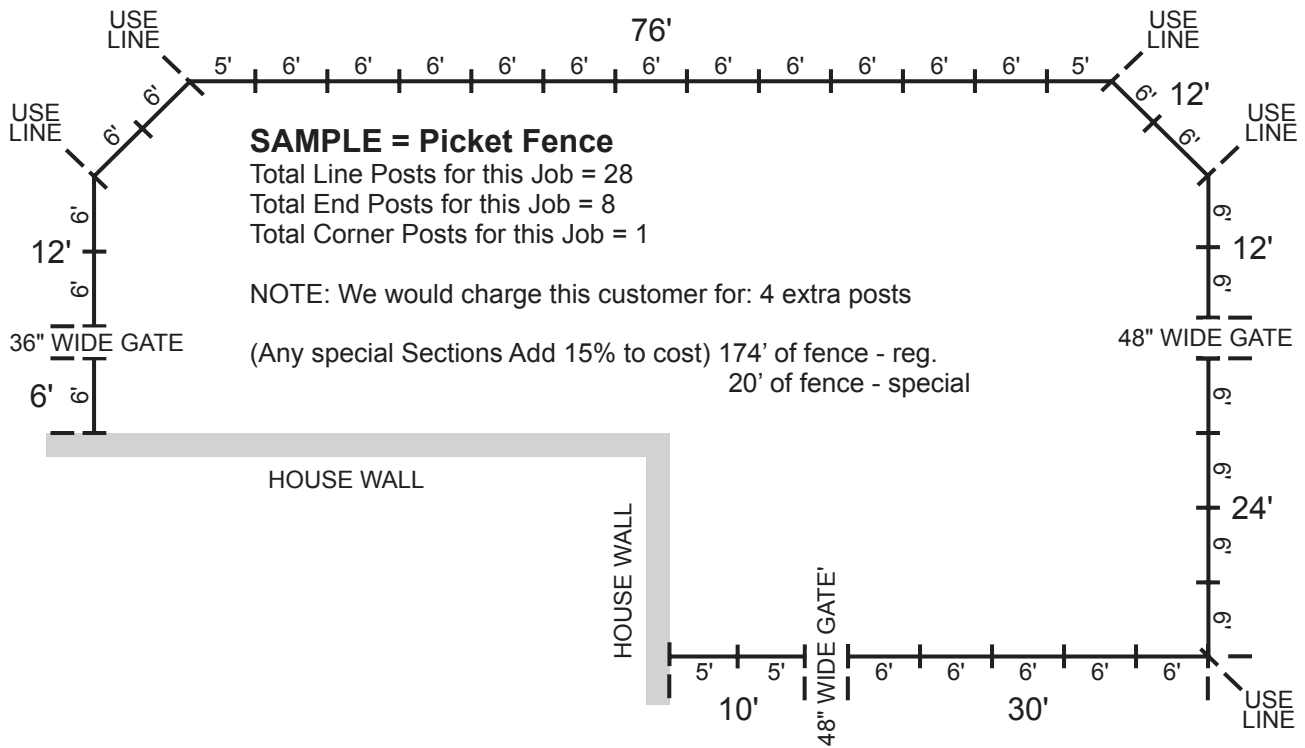

NOTE: Post Spacing Differs on Styles of Fence

Answers Needed for These Questions:

- Height of Fence? _____
- Style of Fence? _____
- How Many Line Posts? _____
- How Many End Posts? _____
- How Many Corner Posts? _____
- What Style Caps? _____
- Width of Each Gate? _____
- How Many Hinges? _____
- How Many Latches? _____
- How Many Drop Pin Kits? _____
- How Many Post Inserts? _____

Deluxe and Denmark Picket Fence Installation Instructions

Step 1: Preparation and Digging

First, set stakes and stretch your line. Use spray paint to mark location of holes. Holes should be 28" deep and should be 72½" on center. We recommend a 9" hole auger.

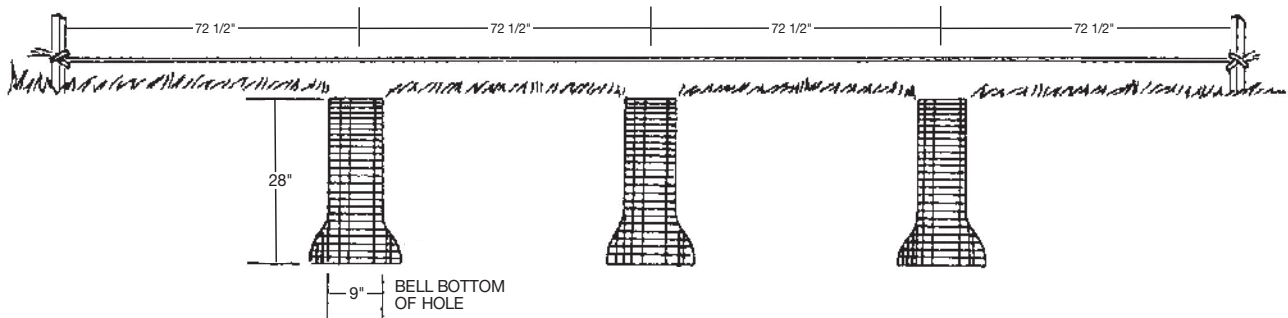

Note: 5' and 6' high fence are 73½" center to center and use a 12" hole auger.

Step 2: Aligning of Fence Post

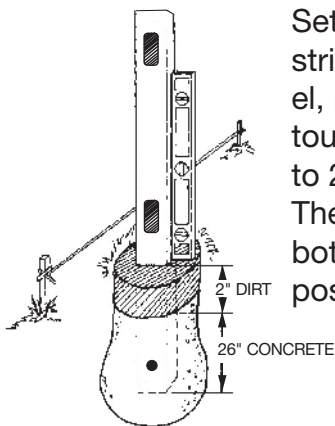

Set corner and end post and mark on string for 72½" centers. Using a 4' level, position post close to string without touching. When post is plumb, fill hole to 2" below ground level with concrete. Then fill the rest with dirt. Be sure that bottom of the routed hole on fence post is 5" above ground.

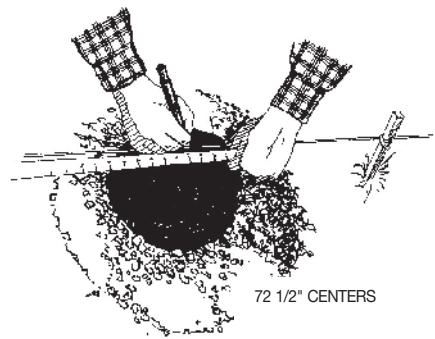

For ease of installation, mark your level where top of post should be allowing for 5" spacing of bottom routed hole, keeping your level on the ground.

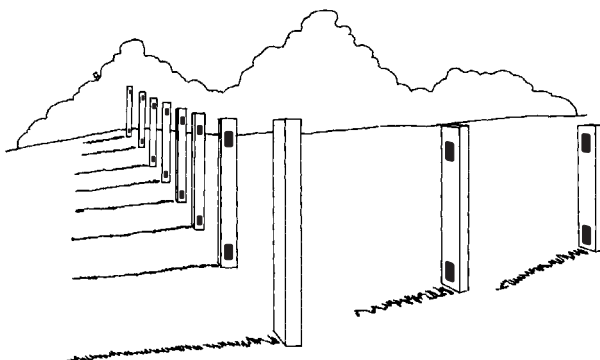

After all posts are in, sight across top of posts to ensure posts follow the contour of the land. Adjust posts accordingly and check for plumb by sighting down the side of the posts. Allow posts to set over-night before installing sections.

Follow contour of land and avoid choppy up and down look.

Deluxe and Denmark Picket Fence Installation Instructions

Step 3: Gate Post Installation

4" Posts: "Standard"™ Residential and "Select"™ Hardware. Single Gate opening should be 2" wider than gate. Double Gate opening should be 3" wider than gate.

5" Posts: "Standard"™ Commercial Hardware. Single Gate opening should be 3" wider than gate. Double Gate opening should be 4½" wider than gate.

Slip aluminum post insert into PVC post before inserting rails into posts.

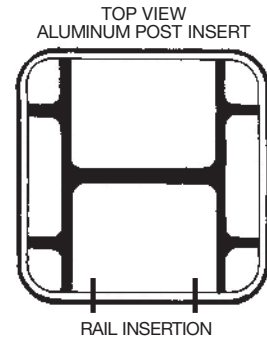
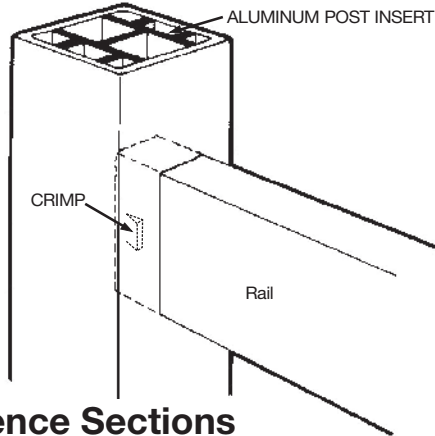

Note: Make sure the wide part of the Aluminum insert is facing toward the holes in post.

Step 4: Installing Fence Sections

Insert 2 x 4 rails into post. Insert screws into pre-drilled holes and then with electric drill affix pickets to rails being sure to insert screws into guide holes on pickets. Finish by gluing post caps on.

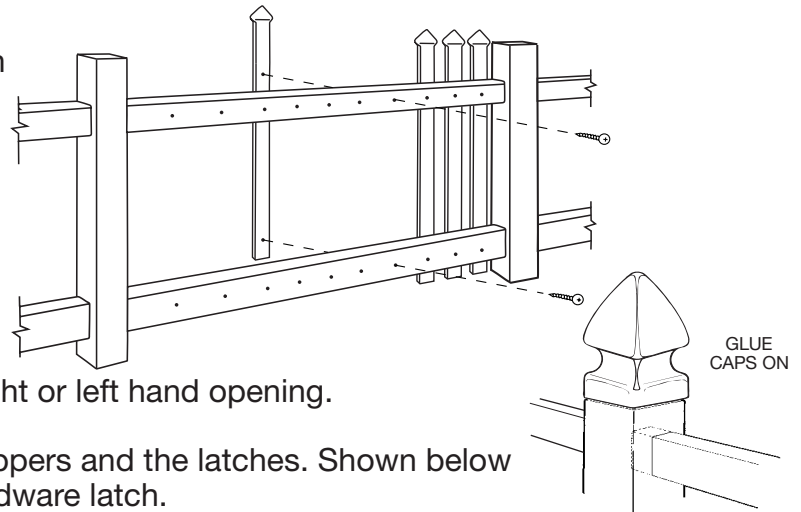

Note: Gate springs available. Gate springs must be used for (2-way latch available for 4" posts)



Step 5: Installation of Gate

The gate hardware can be used for a right or left hand opening.

It simply is a matter of reversing the clappers and the latches. Shown below is the proper positioning of the gate hardware latch.

Bottom of latch must be 54" from ground level for Pool Code

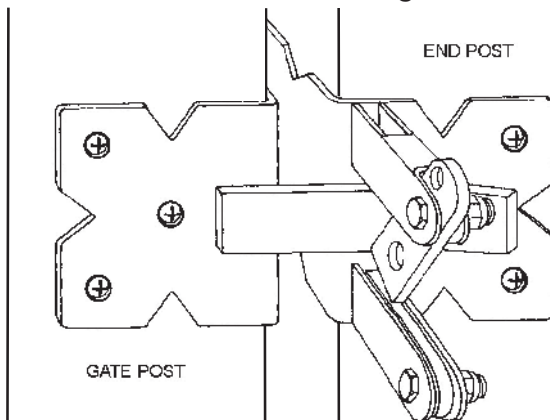

Note: Looks best when hinges line up with horizontal rails.

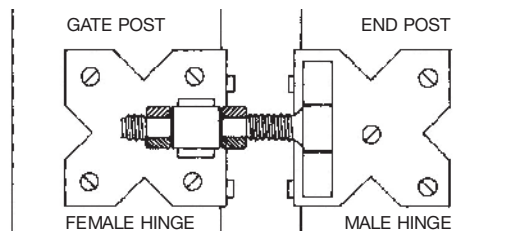

Hinges should be installed as such: the male hinge is mounted on the end post and has adjustable nuts to compensate for opening. The female hinge is mounted on the gate itself.