

# Round Column Pergola Parts

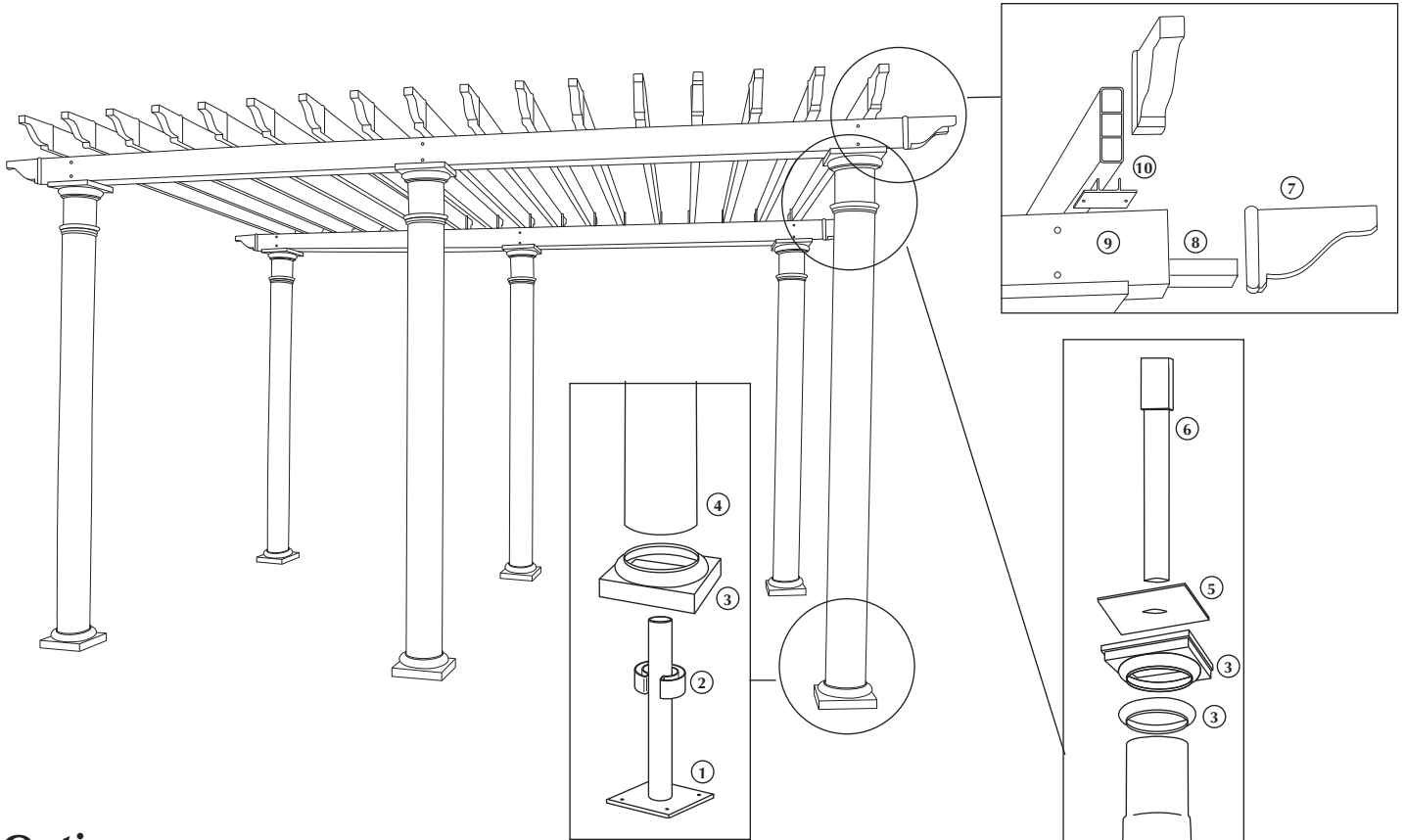

## Options

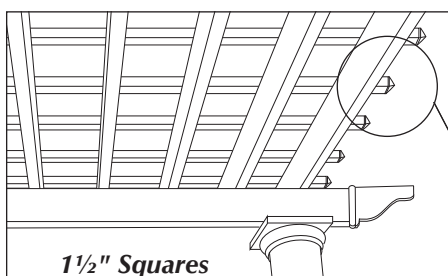
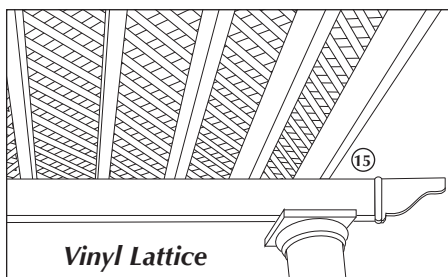
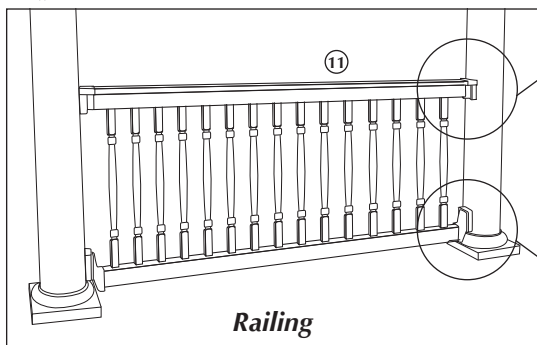

## Parts

1. Pergola concrete mount assembly
2. Round column railing bracket insert
3. Round column trim package
4. Round column
5. Round column top trim guard
6. Pergola aluminum beam bracket
7. Pergola end cap
8. Pergola beam aluminum reinforcement channel
9. Vinyl 2" x 6" w/ribs
10. Pergola stringer brackets
11. Railing section
12. Round column railing mounting bracket adapter (set)
13. T-rail bracket
14. Round column bottom rail step-down bracket
15. Lattice
16. Vinyl 1 1/2" x 1 1/2"
17. Vinyl 1 1/2" square ends
- NS. 2" x 6" wall mounting bracket

Pergolas are assembled from components ordered individually to meet the specifications of your design. Your local dealer or contractor will be able advise you of the different post profiles and sizes, beam and rafter specifications, railing, or other options.

Easy to follow installation instructions are available to assist you with your project.

# Round Column Pergola Parts

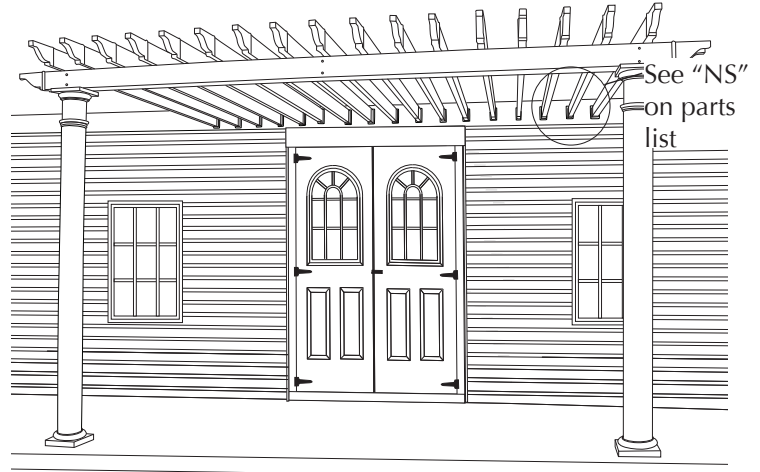
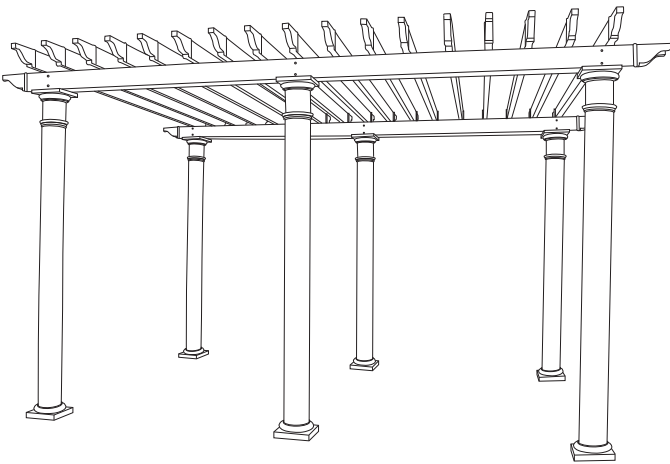

(\* Runner & header size.)  
 (Post also available in 5"sq. & 6"sq.)

Anything over the span of 10' has a tendency to sag 1/4" to 1".

## List of Typical Parts Required

PERGOLA SIZE*	8' x 8'	8' x 10'	8' x 12'	8' x 16'	8' x 20'	10' x 10'	10' x 12'	10' x 16'	10' x 20'	10' x 24'
PART DESCRIPTION	QUANTITY/LENGTH									
2" x 6" runner	7/8'	8/8'	10/8'	13/8'	16/8'	8/10'	10/10'	13/10'	16/10'	19/10'
2" x 8" header	4/8'	4/10'	4/12'	4/16'	4/20'	4/10'	4/12'	4/16'	4/20'	4/24'
1 3/4" x 1 3/4" alum. channel	7/8'	8/8'	10/8'	13/8'	16/8'	8/10'	10/10'	13/10'	16/10'	19/10'
1 3/4" x 1 3/4" alum. channel	4/8'	4/10'	4/12'	4/16'	4/20'	4/10'	4/12'	4/16'	4/20'	4/24'
8" or 10" round column	4	4	4	6	6	4	4	6	6	6
8" or 10" round col. trim set	4	4	4	6	6	4	4	6	6	6
8" or 10" round col. concrete mount assem.	4	4	4	6	6	4	4	6	6	6
2" x 6" pergola end	14	16	20	26	32	16	20	26	32	38
2" x 8" pergola end	8	8	8	8	8	8	8	8	8	8
2" stringer bracket	28	32	40	52	64	32	40	52	64	76
#8 x 1" screw	115	130	160	208	256	130	160	210	258	305

PERGOLA SIZE*	12' x 12'	12' x 16'	12' x 20'	12' x 24'	16' x 16'	16' x 20'	16' x 24'	20' x 20'	20' x 24'	24' x 24'
PART DESCRIPTION	QUANTITY/LENGTH									
2" x 6" runner	10/12'	13/12'	16/12'	19/12'	13/16'	16/16'	19/16'	16/20'	19/20'	38/12'
2" x 8" header	4/12'	4/16'	4/20'	4/24'	4/16'	4/20'	4/24'	6/20'	6/24'	6/24'
1 3/4" x 1 3/4" alum. channel	10/12'	13/12'	16/12'	19/12'	13/16'	16/16'	19/12'	16/20'	19/20'	19/24'
1 3/4" x 1 3/4" alum. channel	4/12'	4/16'	4/20'	4/24'	4/16'	4/20'	4/24'	6/20'	6/24'	6/24'
8" or 10" round column	4	6	6	6	6	6	6	9	9	9
8" or 10" round col. trim set	4	6	6	6	6	6	6	9	9	9
8" or 10" round col. concrete mount assem.	4	6	6	6	6	6	6	9	9	9
2" x 6" pergola end	20	26	32	38	26	32	38	32	38	38
2" x 8" pergola end	8	8	8	8	8	8	8	12	12	12
2" stringer bracket	40	52	64	76	52	64	76	96	114	114
#8 x 1" screw	160	210	256	305	210	256	305	384	456	460

# 5" Design Posts Pergola Parts

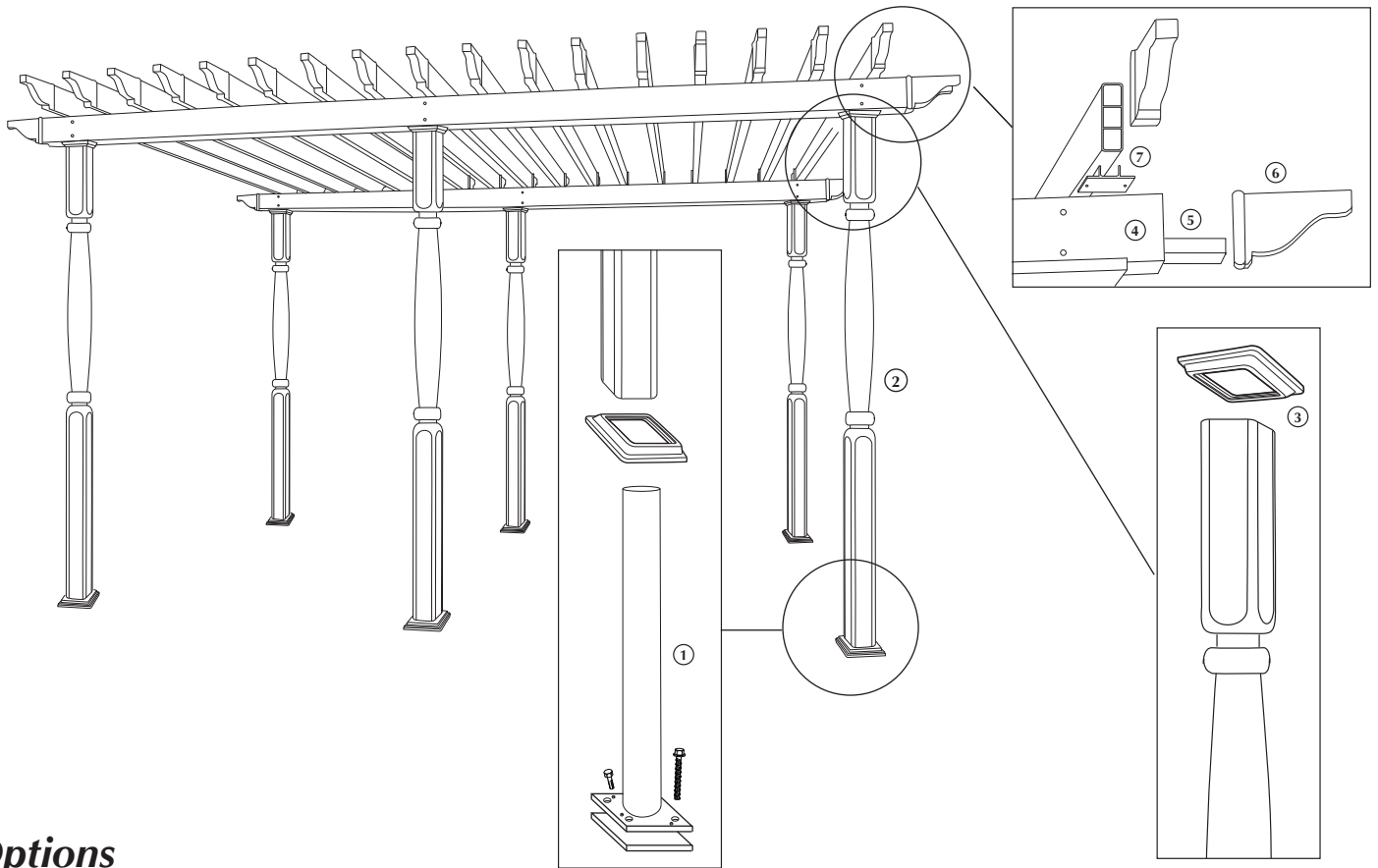

## Options

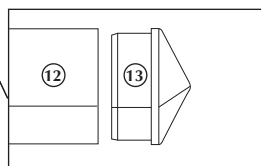
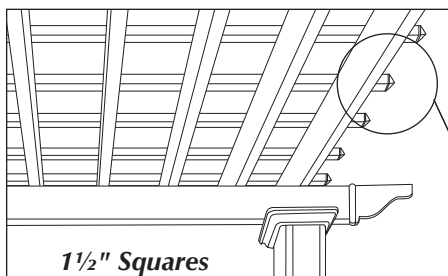
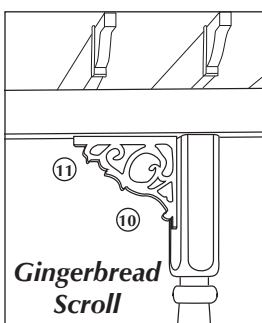
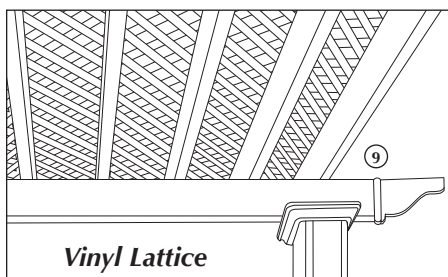
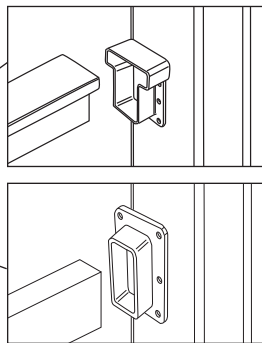
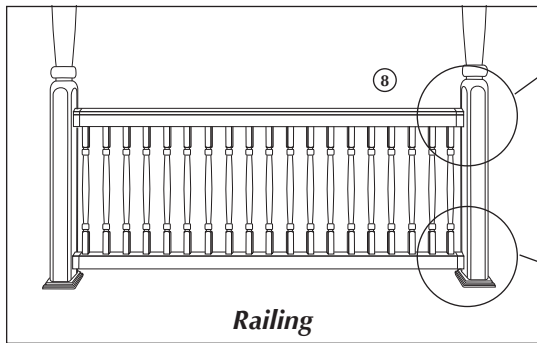

## Parts

1. Concrete mount assembly
2. 5" Design post
3. 5" 1 piece post trim
4. Vinyl 2" x 6" w/ribs
5. Pergola beam aluminum reinforcement channel
6. Pergola end cap
7. Pergola stringer brackets
8. Railing section
9. Lattice
10. Gingerbread scroll trim (requires a 5" x 5" filler piece between the posts)
11. Vinyl 5" x 5"
12. Vinyl 1 1/2" x 1 1/2"
13. Vinyl 1 1/2" square ends
- NS. 2" x 6" wall mounting bracket

Pergolas are assembled from components ordered individually to meet the specifications of your design. Your local dealer or contractor will be able advise you of the different post profiles and sizes, beam and rafter specifications, railing, or other options.

Easy to follow installation instructions are available to assist you with your project.

# 5" Design Posts Pergola Parts

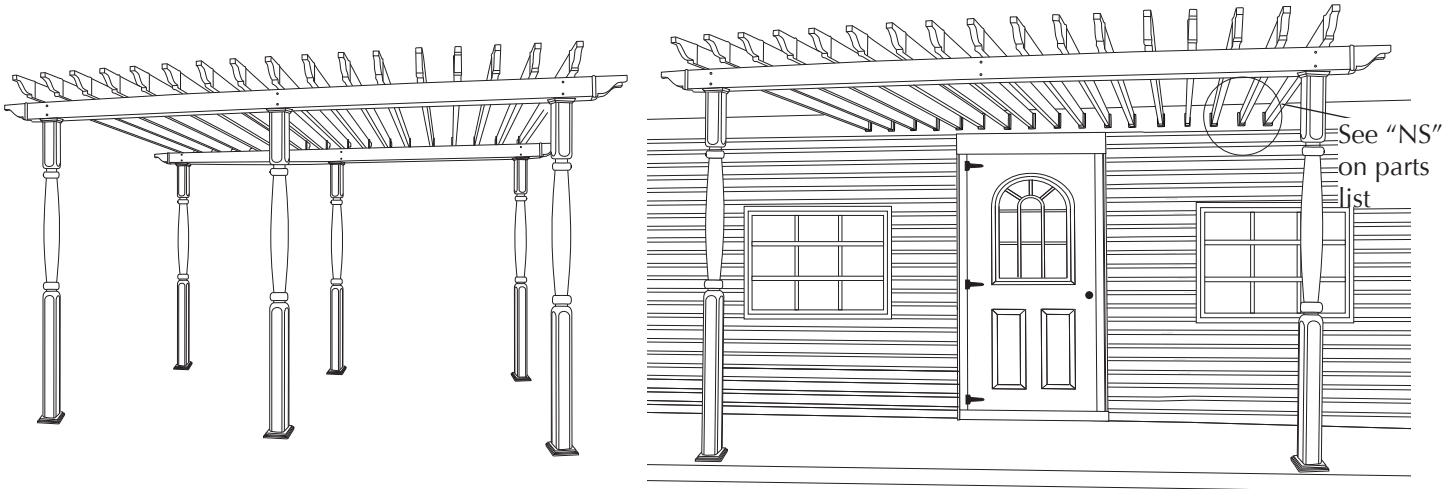

(\* Runner & header sizes)  
 (Post also available in Round  
 Columns & 6" Sq. Posts.)

## List of Typical Parts Required

Anything over the span of  
 10' has a tendency to sag.

PERGOLA SIZE *	8' x 8'	8' x 10'	8' x 12'	8' x 16'	8' x 20'	12' x 12'	12' x 16'	12' x 20'	16' x 16'	16' x 20'
PART DESCRIPTION	QUANTITY/LENGTH									
1½" x 5½" runner	7/8'	8/8'	10/8'	13/8'	16/8'	10/12'	13/12'	16/12'	13/16'	16/16'
2" x 6" header	4/8'	4/10'	4/12'	4/16'	4/20'	4/12'	4/16'	4/20'	4/16'	4/20'
1¼" x 1¾" alum. channel	7/8'	8/8'	10/8'	13/8'	16/8'	10/12'	13/12'	16/12'	13/16'	16/16'
1¾" x 1¾" alum. channel	4/8'	4/10'	4/12'	4/16'	4/20'	4/12'	4/16'	4/20'	4/16'	4/20'
5" x 104" straight post	4	4	4	6	6	4	6	6	6	6
5" sq. 1 piece trim	8	8	8	12	12	8	12	12	12	12
5" sq. concrete mount assem.	4	4	4	6	6	4	6	6	6	6
1½" x 5½" pergola end	14	16	20	26	32	20	26	32	26	32
2" x 6" pergola end	8	8	8	8	8	8	8	8	8	8
1½" stringer bracket	28	32	40	52	64	40	52	64	52	64
#8 x 1" screw	115	130	160	208	256	160	210	256	208	256